



THE NEXT EVOLUTION OF KREG® TOOLS

The newest joining and cutting solutions



NEW PRODUCTS

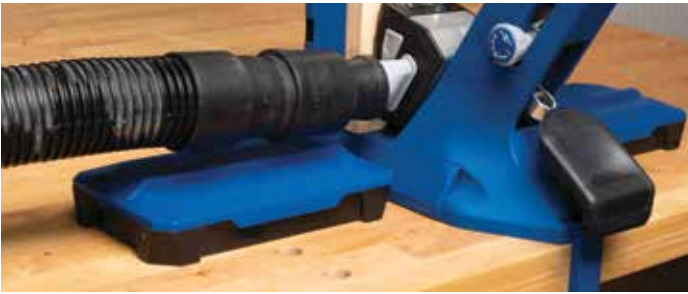

POCKET-HOLE JIG 720PRO
PAGE 6



POCKET-HOLE JIG 720
PAGE 7



POCKET-HOLE JIG 520PRO
PAGE 8



CROSSCUT STATION
PAGE 28



PORTABLE CROSSCUT
PAGE 29



STRAIGHT EDGE GUIDE
PAGE 30

WHAT'S NEW WITH KREG

At Kreg, it's always been our goal to create wood project solutions that make building fun and approachable for anyone. Many of us are woodworkers, with skill levels ranging from DIY newbies to seasoned pros. Our products are designed to fit your project needs, no matter who you are or how long you've been building. And this year we have a lot of exciting new offerings for you.

We're continuing to build on our legacy of pocket-hole joinery with the launch of our newest generation of pocket-hole jigs. You've never seen jigs like these before – they're sure to bring best-in-class speed, simplicity, and efficiency to your projects. I can't wait for you to discover your new favorite pocket-hole jig.

This year we're also introducing some new ways to solve your cutting challenges. Our latest guided cutting products will show you how easy it is to get straight, accurate, repeatable cuts using just a circular saw. And with these products, guided cutting is more versatile than ever – so you can cut down material exactly how you need it, wherever you build.

No matter what skill level you're at in your project building journey, Kreg will be there to guide you.

Todd Sommerfeld, President and CEO



POCKET-HOLE JOINERY

POCKET-HOLE JIG 720PRO	6-7
POCKET-HOLE JIG 720	7
POCKET-HOLE JIG 520PRO	8-9
POCKET-HOLE JIG 300-SERIES	10-11
POCKET-HOLE JIG ACCESSORIES	14-15
POCKET-HOLE MACHINERY	16-21

POCKET-HOLE JIGS THAT MATCH YOUR PROJECT-BUILDING NEEDS

When your projects call for joinery that's fast, strong, and easy to execute, Kreg® has you covered. With our complete line of pocket-hole jigs, you can easily find one that matches your building style, your budget, and your needs.



NEW 700-Series

NEW Docking Station

NEW 500-Series

HD

300-Series

POCKET-HOLE JIG 720PRO

The Pocket-Hole Jig 720PRO is the most advanced jig yet from Kreg® with features that make project building incredibly efficient. One-motion clamping with Automaxx™ automatically adjusts to the exact material thickness and clamps seamlessly.

Included with the 720PRO are the Kreg® Docking Station material support wings with a repeatable stop, as well as a Pocket-Hole Jig Clamp. Use the Pocket-Hole Jig Clamp to secure the jig to a workstation, while material support wings add support when drilling into large pieces. Best of all, the wings fold up and stow away easily when not in use. These premium additions provide more storage, more material support, and more stability.

With the Pocket-Hole Jig 720PRO, you get the Kreg Docking Station material support wings with a repeatable stop, a Pocket-Hole Jig Clamp, 160 Kreg pocket-hole screws, and a free project plan so you can start building right away.



INCLUDES

- Docking Station material support wings, repeatable stop, and Pocket-Hole Jig Clamp
- 160 Kreg® pocket-hole screws and project plan
- Easy-set drill bit and driver bits (3" and 6")
- Material thickness gauge
- Dust collection attachment

BUILD POCKET-HOLE PROJECTS FASTER THAN EVER



FEATURES



GripMaxx™ anti-slip holds material in place for worry-free clamping



Multi-featured jig for creating pocket-hole joints in materials from 1/2" to 1 1/2" thick



Material support wings add more storage and enhanced support for large pieces



720PRO also includes the Pocket-Hole Jig Clamp to secure the jig to a workstation



On-board storage keeps accessories close at hand



Dual-action clamping with Automaxx® automatically clamps and adjusts to the proper material thickness

POCKET-HOLE JIG 720

The Pocket-Hole Jig 720 was designed for efficient project building with advanced features like one-motion Automaxx™ clamping and automatic material thickness setting for pieces from 1/2" to 1 1/2" thick. With the Pocket-Hole Jig 720, you get 60 Kreg pocket-hole screws and a free project plan so you can start building right away.



On-board storage keeps accessories close at hand



GripMaxx™ anti-slip holds material in place for worry-free clamping



ITEM# KPHJ720

INCLUDES

- 60 Kreg® pocket-hole screws and project plan
- Easy-set drill bit (6") and driver bits (3" and 6")
- Material thickness gauge

POCKET-HOLE JIG 520PRO

The Pocket-Hole Jig 520PRO is the most versatile jig yet from Kreg® with features that adapt to different project-building needs. VersaGrip™ makes clamping intuitive – just squeeze the handle until the material is clamped securely. It also rotates 360° for convenient use of the jig in multiple orientations.

Preset material thickness settings make setup fast, and an adjustable stop offers repeatability when drilling pocket holes in multiple pieces of similar thickness.

The Pocket-Hole Jig 520PRO includes a 2" face clamp, 100 Kreg pocket-hole screws, and a free project plan.



ITEM# KPHJ520PRO

DRILL GUIDE
LIFETIME
WARRANTY

INCLUDES

- 2" Kreg® clamp
- 100 Kreg® pocket-hole screws and project plan
- Easy-set drill bit and driver bit (6")
- Material thickness gauge

BUILD POCKET-HOLE PROJECTS ANYTIME, ANYWHERE



FEATURES



Versatile jig for creating pocket-hole joints in materials from 1/2" to 1 1/2" thick



GripMaxx™ anti-slip holds material in place to prevent shift while drilling



Intuitive clamping with VersaGrip™ and a 360°-rotating handle



Durable construction with steel-reinforced spine and lifetime drill guide warranty



Sets up fast with easy-to-use material thickness settings



Includes 2" face clamp

DOCKING STATION

Expand the capability of the Kreg® Pocket-Hole Jig 520PRO with the Docking Station – complete with material support wings, added storage, and a Pocket-Hole Jig Clamp to secure the jig to a workstation. All these together create the ultimate benchtop joining station for the Pocket-Hole Jig 520PRO.

FEATURES

- Create a premium benchtop joining station by docking the 520PRO jig into the base
- Get enhanced support for long pieces with repositionable material support wings
- Material support wings also provide additional storage for your bits, screws, and more
- Adjustable Stop adds repeatability and speed to pocket-hole positioning
- Includes the Pocket-Hole Jig Clamp to secure your jig to a work surface
- Also works with Pocket-Hole Jig 720
- Material support wings fold up when not in use

INCLUDES

- Material Support Wings
- Adjustable Stop
- Pocket-Hole Jig Clamp (KPHA760)
- Dock Connection Adapters for KPHJ720
- Base Connection for KPHJ520PRO



NEW
★ ★ ★

ITEM# KPHA750

POCKET-HOLE JIG 320

The Kreg® Pocket-Hole Jig 320 makes it easy to build wood projects — whether you're building your first DIY project, or you've been working with wood for years. The Pocket-Hole Jig 320 uses a simple, easy-to-understand setup process that gives you the versatility you need to build with boards and plywood of any thickness between ½" and 1 ½". The 320 features two drill guides, a removable spacer, and convenient material-thickness stops.

The included material thickness gauge and easy-set drill bit make setup simple, while the convenient clamp adapter and GripMaxx™ anti-slip base hold the jig precisely in position while you drill perfectly positioned pocket holes every time. The jig and its included components store in a durable, compact case that even has space to store Kreg Pocket-Hole Screws — with 40 sample screws included. Durable construction and hardened-steel guides with a lifetime warranty ensure that the Kreg Pocket-Hole Jig 320 will deliver the years of project-building and home-repair satisfaction

ITEM# KPHJ320



**DRILL GUIDE
LIFETIME
WARRANTY**

SPECS

- Works with materials from ½" to 1 ½" (13-38mm)-thick; adjustable stops at ½", ¾", 1 ½" (13, 19, 38mm)
- Two ¾" (9mm) diameter Drill Guides ¾", 1 ½" (19mm, 38mm), pocket-hole spacing, unlimited when guides separated
- Compatible with 300-Series accessories

INCLUDES

- | | |
|--|--------------------------------|
| (2) Drill Guides with Material Thickness Stops | (1) Thickness Gauge/Hex Wrench |
| (1) Drill Guide Spacer | (1) 6" Square-Drive Bit |
| (1) Clamp Adapter | (1) Carrying Case |
| (1) Easy-Set Drill Bit and Stop Collar | (40) Sample Screws |

THE COMPLETE POCKET-HOLE KIT FOR BUILDING DIY WOOD PROJECTS



FEATURES



Twist-apart design

Drill Guides and Spacer twist and lock to make it easy to set pocket-hole spacing.



Easy-set drill bit

Engraved drill bit markings and stop collar with sight window make drill bit setup simple.



Clamp adapter

Convenient attachment for simple and quick clamping using Kreg® and other clamps.



Material thickness gauge / hex wrench

Helps set correct drill-bit depth, doubles as a hex wrench.

POCKET-HOLE JIG 310

The Kreg® Pocket-Hole Jig 310 makes it easy to build wood projects—whether you're building your first DIY project, or you've been working with wood for years. The Pocket-Hole Jig 310 uses a simple, easy-to-understand setup process that gives you the versatility you need to build with boards and plywood of any thickness between ½" and 1 ½". It features a hardened-steel drill guide and a convenient material-thickness stop.

The included material thickness gauge and easy-set drill bit make setup simple, and the GripMaxx™ anti-slip base holds the jig precisely in position while you drill perfectly positioned pocket holes every time. Durable construction and a lifetime drill-guide warranty ensure that the Kreg Pocket - Hole Jig 310 will deliver the years of project-building and home-repair satisfaction and value you expect from the #1 pocket-hole brand—Kreg®.



INCLUDES

- (1) Drill Guide with Material Thickness Stops
- (1) Easy-Set Drill Bit and Stop Collar
- (1) Material Thickness Gauge/Hex Wrench
- (1) 6" Square-Drive Bit

SPECS

- Works with materials from ½" to 1 ½" (13-38mm)-thick; adjustable stops at ½", ¾", 1 ½" (13, 19, 38mm)
- ⅜" (9mm) diameter Drill Guide
- Compatible with 300-Series accessories

THE VERSATILE, SIMPLE, DURABLE POCKET-HOLE JIG FOR BUILDING DIY WOOD PROJECTS



FEATURES



Expandable design

Multiple 310s can be used together for fast, easy drilling of multiple pocket holes.



Easy-set drill bit

Engraved bit markings and stop collar with sight window make bit setup simple.



Material thickness gauge / hex wrench

Helps set correct drill-bit depth, doubles as a hex wrench.

POCKET-HOLE JIG HD

Bigger pocket-hole screws for bigger projects. The Kreg Jig® HD delivers the strength and confidence you need to BUILD BIG! It's perfect for 2x4 and larger lumber.

The Kreg Jig® HD lets you create joints in 1 1/2" (38mm) and thicker materials that are an amazing 50% stronger than traditional Kreg Joints™. The HD can be clamped to the workpiece using a Kreg Wood Project Clamp or Face Clamp. Or you can use it in your Kreg Pocket-Hole Jig K5, K4, or K3 in place of the standard drill guide block.

INCLUDES

- (1) HD Drill Guide
- (1) Stop Block
- (1) 1/2"-diameter HD Stepped Drill Bit
- (1) HD Driver Bit
- (1) Stop Collar
- (1) Hex Wrench
- (1) Sample Kreg® HD Screw Set
- (1) Owner's Manual

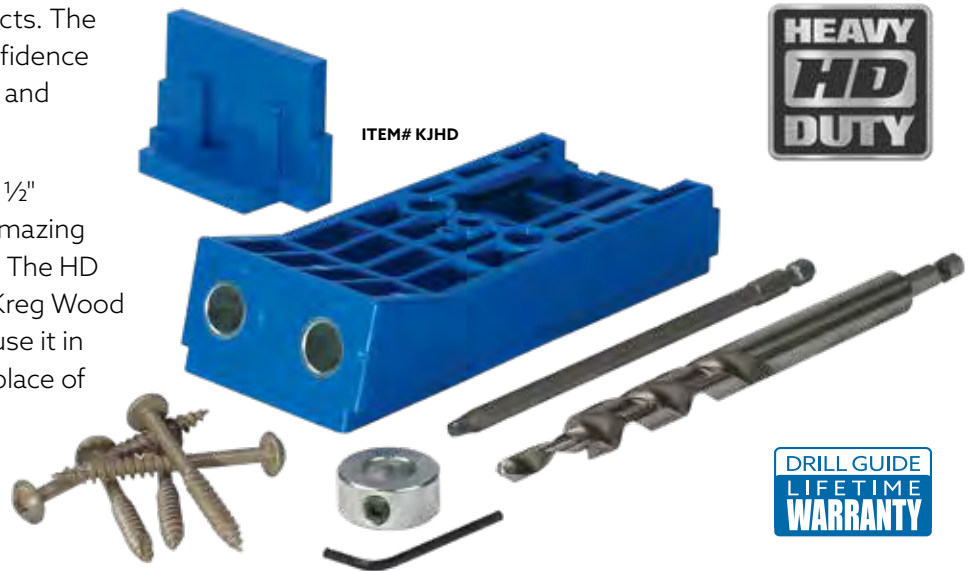

SPECS

- Glass-filled nylon construction
- 2 drill guides
- Drill guide spacing: 1 7/16"

NOTE: Be sure to check with your local building code authority before using the HD to construct load-bearing objects, such as interior walls or deck railings. Building codes differ from area to area. Please refer to the applications in the owner's manual or kregtool.com for more information



FOREMAN

The Foreman Pocket-Hole Machine offers all of the features and capabilities of our professional-grade machines in a tool that's versatile, portable, and extremely affordable. From contractors and cabinet shops to dedicated hobbyists, the Foreman DB210 is perfect for anyone who is serious about pocket-hole joinery. In no time, you will be building with twice the speed and half the effort of a standard pocket-hole jig.

With the Foreman, just squeeze the trigger and pull the handle to start the motor, clamp your workpiece, and drill a perfect pocket hole. The adjustable fence positions the workpiece for precise pocket-hole depth, and adjustable stops provide repeatable accuracy. Built-in dust collection minimizes the mess and speeds the drilling process.

A 120-volt motor enables fast drilling, and a quick-change chuck allows for fast, tool-free bit changes. Plus, the Foreman creates all three types of Kreg® pocket holes: Standard, Micro-Pocket™, and HD (Heavy-Duty). Micro and HD bits and bushings sold separately.

INCLUDES

- | | |
|--|------------------------------------|
| (1) Foreman Pocket-Hole Machine | (1) Drill Bit Setting Block |
| (1) Adjustable Fence with Spring-Loaded Stop | (1) Hardened-Steel Drill-Bit Guide |
| (1) Dust-Collection Attachment | (1) Owner's Manual |
| (1) Kreg Stepped Pocket-Hole Bit | |



ITEM# DB210



SPECS

- 120-volt motor
- Accepts Kreg Standard, Micro & HD bits
- 1 second cycle time
- 1 ½" material clamping capacity
- Up to ½" to 1 ½" hole centering capacity
- Weighs approximately 20 lbs.
- Table top: 14" x 23 ½"
- Whole unit: 15" x 19" x 29 ½"
- 1 year limited warranty



STANDARD FOREMAN BIT

Keep a standard replacement bit on hand, just like the ⅜" (10mm) diameter bit that comes with your Foreman. This hex-shank bit also works with Kreg Jigs®.

Standard Replacement Bit without Drill Guide



ITEM# KPHA300

HD ACCESSORIES

HD—the accessory to have when you want to BUILD BIG! You can build outdoor projects, construct strong deck rails, and even frame walls. Coated #14 screws create super-strong joints. You'll need the bit and drill guide to get started. Replacement bit is also available.



HD Drill Bit with Drill Guide

ITEM# DB210-HDDB



HD Replacement Bit without Drill Guide

ITEM# DB210-HDB

POCKET HOLE-JIG ACCESSORIES



ITEM# KPHA530

POCKET-HOLE JIG MICRO-POCKET™ DRILL GUIDE KIT FOR 500-SERIES

Use a 500-Series Pocket-Hole Jig to create 25% smaller pocket holes – great for small projects, 1/2" material, and narrow stock. For use with 500-Series Pocket-Hole Jigs. Compatible with Kreg® pan-head pocket-hole screws. Includes a Micro-Pocket™ Drill Guide Block, Easy-Set Micro-Pocket™ Drill Bit and Stop Collar, and Material Thickness Gauge.



ITEM# KPHA540

EASY-SET MICRO-POCKET™ DRILL BIT WITH STOP COLLAR & GAUGE/HEX WRENCH

The Easy-Set Micro-Pocket™ Drill Bit with Stop Collar & Gauge/Hex Wrench is designed for use with the Micro-Pocket™ Drill Guide Kit (KPHA530 and KPHA730) to create 25% smaller pocket holes using 500-Series and 700-Series Pocket-Hole Jigs. Includes an Easy-Set Micro-Pocket™ Drill Bit and Stop Collar and Material Thickness Gauge/Hex Wrench.



ITEM# KPHA730

POCKET-HOLE JIG MICRO-POCKET™ DRILL GUIDE KIT FOR 700-SERIES

Use a 700-Series Pocket-Hole Jig to create 25% smaller pocket holes – great for small projects, 1/2" material, and narrow stock. For use with 700-Series Pocket-Hole Jigs. Compatible with Kreg® pan-head pocket-hole screws. Includes a Micro-Pocket™ Drill Guide Block, Easy-Set Micro-Pocket™ Drill Bit and Stop Collar, and Material Thickness Gauge.



ITEM# KPHA740

CUSTOM PLUG CUTTER DRILL GUIDE KIT

Create standard-sized plugs that blend perfectly into your pocket-hole projects. Insert the plug cutter drill guide block into your Kreg® 700-Series Pocket-Hole Jig, then use the plug-cutting drill bit to create custom plugs from your desired material. Drill guide for use only with 700-Series Pocket-Hole Jigs. Includes a Plug Cutter Drill Guide Block, Standard Plug Cutter Drill Bit and Stop Collar, and Hex Wrench.



UNIVERSAL CLAMP ADAPTER

Make it even easier to hold your 300-Series Pocket-Hole Jig in position as you work using the Universal Clamp Adapter. The Universal Clamp Adapter fits into the drill guide and accepts any Kreg Clamp, as well as most trigger-action clamps. The adapter locks onto the clamp, so the jig is held securely, and you can move and position the jig using just one hand.



POCKET-HOLE JIG SPACERS

Expand the capability of your Pocket-Hole Jig 320 by adding more hole-spacing options. This kit includes two Pocket-Hole Jig Spacers that fit between the drill guides, so you can easily increase the spacing between holes by $\frac{3}{4}$ " increments to match your project needs. The spacers fit in place beside the drill guides, or beside another spacer, and lock into place with a simple twist.



POCKET-HOLE JIG EXPANSION PACK

Expand the capability of your Pocket-Hole Jig 310 or 320 by adding another drill guide to drill more holes, plus a spacer that adds more hole-spacing options. The Pocket-Hole Jig Expansion Pack includes one hardened-steel drill guide with convenient material-thickness stops, so you can add a second guide to your Pocket-Hole Jig 310, or add a third to the Pocket-Hole Jig 320. This kit also includes a Pocket-Hole Jig Spacer that provides more pocket-hole spacing options.

DRILL BITS



EASY-SET POCKET-HOLE DRILL BIT

This bit features engraved markings for $\frac{1}{2}$ ", $\frac{3}{4}$ ", and 1 $\frac{1}{2}$ " materials to match up with the Easy-Set Stop Collar. A $\frac{1}{4}$ " hex shank fits all standard quick-change chucks. Compatible with all Kreg Pocket-Hole Jigs.

DRILL BITS

Kreg® drill bits feature a one-piece design that eliminates clogging and provides a much smoother, faster drilling stroke than the drill bits with replaceable center drills. The Easy-Set Bit for our manual Pocket-Hole Jigs is made of high-speed steel, while the DKDB Machine bit is made of cobalt-steel to increase bit life. Because the DKDB Bit is $\frac{3}{8}$ " (10mm) in diameter, it can be used in any manual Kreg Jig® as a premium replacement. Be sure to order the left-handed drill bit (LH-DKDB) for the center spindle of the DK3100 fully-automatic machine.

DRIVERS

Kreg square-drive bits have deep tips that greatly reduce cam-out when driving screws. #2 drivers (for all except HD screws) come in 3" (76mm) and 6" (152mm) lengths. The 6" length is easiest to use in most applications, while the 3" is perfect for working in tight spots. The #3 HD (Heavy Duty) driver comes in 6" length only.

- #DDS 3" (76mm) & 6" (152mm) #2 Square Driver Set
- #D6X2 Two 6" (152mm), #2 Square Driver Set
- #D6HD 6" (152mm) #3 Square Driver for Kreg Jig® HD

- #DKDB
- #LH-DKDB
- #KJDHD
- #KPHA308-Drill bit
- #KPHA330
- #KJD/MICROBIT
- #KJSC/MICROBIT

- For DK1100, DK3100, and DK5100
- For DK3100 Center Spindle (Left Hand)
- For Kreg Jig® HD
- Stop collar and Hex/Gauging wrench
- Stop Collar & Material Gauge/Hex Wrench
- For Micro-Pocket Drill Guide
- Micro-Pocket Depth Collar / Hex Wrench

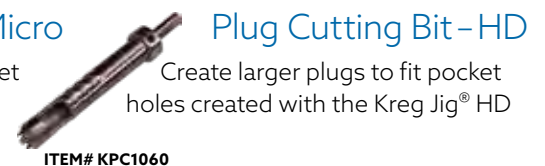

YOUR KREG® PROJECTS DEMAND KREG® SCREWS

Kreg® screws are built with specialized features that work together to ensure the strongest joint possible. They also make driving easy and help to reduce wood splitting. Choosing Kreg® Screws will give you the best results possible. To get these great results, you need to choose the best Kreg screw for your particular project. Choosing the right screw is easy once you understand the features of each screw type and how these features will impact the success of your project. Learn more about how to select the correct Kreg Screw for your project at www.kregtool.com/kregscrows.



Kreg® Screw Container features:

- Easy-to-read, color-coded labels
- Transparent containers
- Resealable, tight-fitting lids
- Nesting ability for easy storage
- Durable, impact-resistant material
- Reusable for storing other hardware
- 100, 250, 500, and 1,200 count sizes



Our stainless screws are specially designed for high-moisture applications, excessive exposure to water, and other exceedingly corrosive environments, such as pressure-treated lumber.

Item#	Thread	Length	Head Style	Qty.	Diameter
SML-C125S5	Coarse	1 ¼" (32mm)	Maxi-Loc™	100	#8
SML-C150S5	Coarse	1 ½" (38mm)	Maxi-Loc™	100	#8
SML-C250S5	Coarse	2 ½" (64mm)	Maxi-Loc™	50, 250, 2000	#10
SML-F125S5	Fine	1 ¼" (32mm)	Maxi-Loc™	100	#7



Blue-Kote™ screws are made from case-hardened steel, and feature three anti-corrosion layers, perfect for indoor and outdoor projects. They provide rust resistance up to 400% greater than zinc-plated screws, and work with pressure-treated material.

Item#	Thread	Length	Head Style	Qty.	Diameter
SML-C125B	Coarse	1 ¼" (32mm)	Maxi-Loc™	100, 1200	#8
SML-C150B	Coarse	1 ½" (38mm)	Maxi-Loc™	100, 1200	#8
SML-C2B	Coarse	2" (51mm)	Maxi-Loc™	50, 250	#8
SML-C250B	Coarse	2 ½" (64mm)	Maxi-Loc™	50, 125, 250, 2000	#8



Our zinc-coated screws are made from case-hardened steel, and are recommended for a wide variety of indoor projects where exposure to moisture is not a significant concern.

Item#	Thread	Length	Head Style	Qty.	Diameter
SML-C1	Coarse	1" (25mm)	Maxi-Loc™	100, 500, 1200	#8
SPS-C1	Coarse	1" (25mm)	Pan Head	100, 250, 500, 1200	#6
SML-C125	Coarse	1 ¼" (32mm)	Maxi-Loc™	100, 250, 500, 1200, 5000	#8
SML-C150	Coarse	1 ½" (38mm)	Maxi-Loc™	100, 250, 500, 1200	#8
SML-C2	Coarse	2" (51mm)	Maxi-Loc™	50, 250, 3000	#8
SML-C250	Coarse	2 ½" (64mm)	Maxi-Loc™	50, 125, 250, 2000	#8
SPS-F075	Fine	¾" (19mm)	Pan Head	100, 500, 1200	#6
SPS-F1	Fine	1" (25mm)	Pan Head	100, 500, 1200	#6
SML-F125	Fine	1 ¼" (32mm)	Maxi-Loc™	100, 250, 500, 1200, 5000	#7
SPS-F125	Fine	1 ¼" (32mm)	Pan Head	100, 500, 1200	#6
SML-F150	Fine	1 ½" (38mm)	Maxi-Loc™	100, 500, 1200	#7
SPS-F150	Fine	1 ½" (38mm)	Pan Head	100, 500, 1200	#6



Kreg HD Screws are designed for use with the Kreg Jig® HD and with 1 ½" and thicker stock. These 2 ½"-long, #14 hardened-steel screws provide incredible shear-resistance, and have a Protec-Kote™ finish with three anti-corrosion layers for long-term moisture resistance. Require a #3 square drive.

Item#	Thread	Length	Head Style	Qty.	Diameter
SML-C2X250	Coarse	2 ½" (64mm)	Maxi-Loc™	30, 125	#14

HARDWARE CONTAINERS

Hardware Containers are the perfect solution for storing and organizing all kinds of loose hardware. These handy containers are the same durable, resealable, reusable containers that are used to package Kreg Screws and Plugs. Hardware Containers have labels you can write on to easily identify what's inside. Available in Small and Large sizes. Sold in packs of four.

SIZES

- Small: 3" wide x 4 1/4" tall x 1 7/8" deep
- Large: 4 1/4" wide x 6 1/4" tall x 1 7/8" deep



Fill Them



Label Them



Stack Them

POCKET-HOLE SCREW KITS

PROJECT KIT

This kit contains five of the most-popular Kreg pocket-hole screw sizes in quantities that are perfect for handling a wide variety of projects, all in a durable carrying case.



Included:	QTY.
SPS-F1	150
SPS-C1	150
SML-F125	150
SML-C125	150
SML-C250B	75

OUTDOOR PROJECT KIT

This kit contains four of the most-popular Kreg Blue-Kote™ weather-resistant pocket-hole screw sizes for building outdoor projects.



Included:	QTY.
SML-C125B	100
SML-C150B	100
SML-C2B	100
SML-C250B	150

STARTER KIT

This kit contains six of the most-popular Kreg pocket-hole screw sizes in a right-sized pack that's perfect to have on hand when project inspiration strikes, or when you need to make repairs.



Included:	QTY.
SPS-C1	50
SML-F125	50
SML-C125	50
SML-C150	50
SML-C250	30
SML-C250B	30

DK1100 SERIES SINGLE-SPINDLE MACHINES

The DK1100 Pro Series machines set the standard in the industry for drilling a single pocket hole at a time. We've packed these machines with functional features that set them apart from the competition. Choose from electric- or pneumatic-powered, freestanding- or bench-mounted to fit the way you build. Each DK1100 machine is built with an industrial-grade motor that provides the power to run day after day — quickly, quietly, and reliably — in even the most high-production environments.



IT WORKS FOR YOU

The DK1100 series allows you to put the speed and productivity of automated pocket-hole drilling to work in your shop, so you can produce more in less time—while still achieving great results. Choose a size and power source that best suits your needs, and you'll have a workshop partner that you can rely on for years of hardworking service.



SWING STOPS

Quickly position pocket holes across rails of various widths by placing them against one stop, drilling the pocket hole, and then repeating with the rail against the other stop.



ADJUSTABLE FENCE

Adjustments couldn't be easier as the fence adjusts right from the top of the machine to let you center a pocket hole in 1/2" (13mm) to 1 1/2" (38mm) thick materials.



ITEM# DK1100 TP



QUICK DRILL BIT CHANGE

Changing drill bit is a quick, simple process. Simply loosen the collet with the included hex wrench, replace with a new bit, and you are back in production in less than 60 seconds!



MOTORS BUILT TO LAST

The industrial-grade motors in Kreg® pocket-hole machines are built for long-lasting service and to minimize stress on moving parts, greatly reducing the likelihood of failure.



ITEM# DK1100 FE

DK1100 FE

Add real productivity and efficiency to your shop with the "Production Pocket-Hole Standard." This model works with any standard 20-amp, 110-volt outlet and features a strong 1 1/2-HP electric motor, single-spindle simplicity, and a cycle time of less than one second.



ITEM# DK1100 FP

DK1100 FP

Already set up for pneumatic? This model features an industrial-grade 1 1/4-HP pneumatic motor that is capable of the same pocket-hole productivity as the electric version. Requires a compressor able to produce 8 CFM at 120 PSI (50% duty cycle).

DK1100 TP

This model is identical to the DK1100 FP, but comes in a much smaller frame. It features a table height of 8" (203mm), making it easy to build into your workbench or relocate from time to time. Requires a compressor able to produce 8 CFM at 120 PSI (50% duty cycle).

MOTOR	DRILL BITS	CFM RATING	CYCLE TIME	MATERIAL CLAMPING CAPACITY	HOLE CENTERING CAPACITY	WEIGHT	DIMENSIONS	WARRANTY
Electric Model: 1 1/2-HP, 110-Volt, Single-Phase Pneumatic Models: 1 1/4-HP	DKDB Drill Bit 3/8" (9.5mm) Shank Dia., 3/4" (5mm) Pilot, 1/2" (13mm)-long	TP & FP: 8-CFM at 50% Duty Cycle (120 PSI) FE: 1 CFM clamp cylinder (90 PSI)	1 second	4" (102mm)	1/2" (13mm) material to 1 1/2" (38mm) material	TP: 77 lbs. (35kg), FP: 138 lbs. (63kg), FE: 176 lbs. (80kg)	TP: 19"H x 24"W x 24"D (500mm)H x (610mm)W x (610mm)D 8" (203mm) table height FP: 50"H x 24"W x 24"D (1270mm)H x (610mm)W x (610mm)D 40" (1000mm) table height FE: 50"H x 24"W x 24"D (1270mm)H x (610mm)W x (610mm)D 40" (1000mm) table height	5 Year Limited Warranty



ITEM# DK3100

DK3100 SERIES MULTI-SPINDLE MACHINE

If you're looking for the ultimate machine to build face frames, this is it. The multi-spindle DK3100 contains three spindles that allow you to drill two pocket holes across rails of varying widths in just one machine cycle. Best of all, the DK3100 can be quickly changed to drill a single pocket hole by simply removing a drill bit. If you're serious about face-frame production, the DK3100 is the machine that will deliver real performance to your shop and profits to your bottom line.

The DK3100 drills two pocket holes in one cycle. Plus, it gives you options for spacing the holes. You can set the drill spindles at $\frac{3}{4}$ " (19mm), 1" (25mm), and $1\frac{3}{4}$ " (44mm) on center, perfect for today's most-common rail widths.

POCKET HOLES TWICE AS FAST!

Multiple spindles give you the option of three different hole spacings to fit today's most common face-frame widths. If you prefer to drill only one pocket hole, no problem! Just remove a drill bit and you get the equivalent of our DK1100 single-spindle machine. Only Kreg® offers you the option of one or two pocket holes at a time and your choice of three different on-center hole spacings IN THE SAME MACHINE!

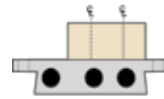

Use $\frac{3}{4}$ " (19mm) spacing on $1\frac{1}{2}$ " (38mm) to $2\frac{1}{4}$ " (57mm) wide material

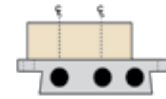

Use 1" (25mm) spacing on $2\frac{1}{4}$ " (57mm) to $2\frac{3}{4}$ " (70mm) wide material

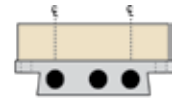

Use $1\frac{3}{4}$ " (44mm) spacing on $2\frac{3}{4}$ " (70mm) to 4" (101mm) wide material

The DK3100 not only drills two pocket holes in one cycle, it also gives you options for spacing the holes. You can set the drill spindles at $\frac{3}{4}$ " (19mm), 1" (25mm) and $1\frac{3}{4}$ " (44mm) on center, perfect for today's most common rail widths.

On-Center Spindle-Spacings: $\frac{3}{4}$ " (19mm), 1" (25mm), $1\frac{3}{4}$ " (44mm)



EASY SETUP

The lift-off top gives you direct access to the drill bits. A simple turn of a hex wrench in the drill bit collets is all it takes to change bits. In less than a minute, you can change any of the three bits or set up the DK3100 for single-spindle drilling.

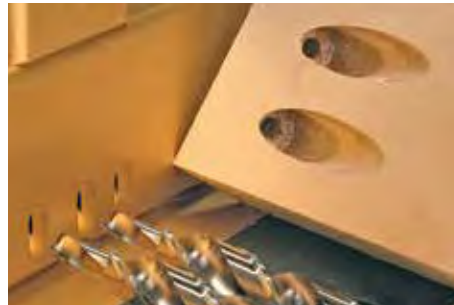

ONE SECOND CYCLE TIMES

Two pocket holes in one second? It's not a dream... It's reality with the DK3100. The one-touch foot pedal activates the spindle to make two perfect pocket holes in one second.



HIGHLY DURABLE

The DK3100 uses a hardened-steel drill guide that supports the drill bits all the way into the workpiece, prolonging drill bit life and improving the cut quality of the pocket hole. The Drill Guide carries a lifetime warranty.

MOTOR	DRILL BITS	CFM RATING	CYCLE TIME	MATERIAL CLAMPING CAPACITY	HOLE CENTERING CAPACITY	WEIGHT	DIMENSIONS	WARRANTY
Electric Model: 1 1/2-HP, 110-Volt, Single-Phase	LH-DKDB and (1) DKDB Drill Bits ($\frac{3}{8}$ " (10mm) Shank Dia., $\frac{3}{16}$ " (5mm) Pilot, $\frac{1}{2}$ " (13mm)-long)	1 CFM clamp cylinder (90 PSI)	1 second	4" (102mm)	$\frac{1}{2}$ " (13mm) material to $1\frac{1}{2}$ " (38mm) material	176 lbs. (80kg)	50"H x 24"W x 24"D (1270mm)H x (610mm)W x (610mm)D (40" (1000mm) table height)	5 Year Limited Warranty

ACCESSORIES



ITEM# DKDB

DKDB DRILL BIT

$\frac{3}{8}$ " (9.5mm) drill bit. Highly heat-resistant, cobalt-steel construction for prolonged bit life.



ITEM# LH-DKDB

LH-DKDB DRILL BIT (DK3100 ONLY)

Left-handed $\frac{3}{8}$ " (9.5mm) drill bit. Highly heat-resistant, cobalt-steel construction for prolonged bit life.



ITEM# DK5100

DK5100 PANEL-BORING MACHINE

Five industrial-grade motors, five individually-activated clamping cylinders, and five durable drill spindles; all in one amazing machine. The DK5100 makes drilling multiple pocket holes across cabinet sides, shelving, stairs, and window or door extensions easier than ever before. It can beat the bottleneck that's slowing down your shop and significantly improve your bottom line.

This machine is built for the shop that has a specific repetitive application that demands increased productivity. The time saved by drilling up to five pocket holes at once is truly dramatic and will allow you to reallocate resources to areas of your shop that need more attention.

INCREASE YOUR SHOP OUTPUT

Imagine how drilling up to five pocket holes at once—in just seconds with the push of one switch—can increase your speed and productivity. And with individual switching of each clamp and cylinder, you can control which holes get drilled quickly and easily.



Don't let bit changes slow you down. The simple and straightforward design of the DK5100—and all of our machines—lets you make easy bit changes in 60 seconds or less.



INDIVIDUAL CONTROL

Each of the five spindles is controlled with an on/off switch located on each clamping tower, giving you instant control of every spindle. Drill with all five spindles at once or turn a couple off to meet the needs of your project.



5 POCKET HOLES, 1 CYCLE

The DK5100's five spindles are spaced 6" (152mm) on-center, the perfect spacing for many panel applications. A simple tap of the foot pedal creates five uniform pocket holes in less than two seconds.



PNEUMATIC POWER

All five drill spindles are driven by industrial-grade pneumatic motors that are designed to provide you with plenty of drilling power, panel after panel, year after year.

MOTOR	DRILL BITS	CFM RATING	CYCLE TIME	MATERIAL CLAMPING CAPACITY	HOLE CENTERING CAPACITY	WEIGHT	DIMENSIONS	WARRANTY
(5) pneumatic, 3/4-HP motors and 6" (152mm) on-center spindle spacings	(5) DKDB Drill Bits 3/8" (9.5mm) Shank Dia., 3/16" (5mm) Pilot, 1/2" (13mm)-long	20 CFM at 50% Duty Cycle (120 PSI)	2 seconds	1 3/4" (44mm)	1/2" (13mm) material to 3/4" (19mm) material	350 lbs. (160kg)	50"H x 36"W x 24"D (1200mm)H x (900mm)W x (610mm)D 40" (1000mm) table height	5 Year Limited Warranty

ACCESSORIES



ITEM# DKDB

DKDB DRILL BIT

3/8" (9.5mm) drill bit. Highly heat-resistant, cobalt-steel construction for prolonged bit life.



SELF-TAPPING POCKET-HOLE SCREWS

These square drive, case-hardened, flat head, self-tapping screws are available in a size and style for any pocket-hole application (page 16).

FACE-FRAMING TABLE

Fast face-frame assembly is great. Fast and accurate assembly that virtually eliminates sanding is even better. The Face-Framing Table has four clamping cylinders that can be precisely adjusted, applying perfect pressure to the joint line on almost any size of frame. The table stands at a 30-degree angle to the user, so it uses less floor space than a flat table. This ergonomic design prevents back pain.



Flush Face Frames Made Easy: 1) Align stile and rail along squaring fence 2) Adjust clamp cylinder and secure joint line 3) Drive self-tapping screw



RETRACTABLE SQUARING FENCE

The aluminum squaring fence on the left side of the table retracts out of the way to accommodate frames longer than 8' (2.4m). Just begin your frame with the squaring fence up, then retract the fence as needed.



CUSTOMIZED SETUP

Each clamping cylinder can be independently controlled, so you can actuate each cylinder individually or activate them all at once with a master switch located at the bottom of the clamping arm.



POWERFUL CLAMPING

The four high-quality clamping cylinders apply tremendous pressure on the joint line to maintain a flush assembly. The clamping arm rolls easily on roller bearings and each cylinder glides smoothly along the arm for perfect positioning.

PERFECTLY SQUARE. PERFECTLY FLUSH.

With squaring fences and powerful pneumatic clamps, the Face-Framing Table makes it easy to create perfectly square face frames with flush surfaces, so you save time fitting and sanding before cabinet assembly. The table reduces fatigue to make you more comfortable and more productive. Plus, the design reduces the space required for the Face-Framing Table, so you get a superior-quality workstation without taking up more floor space than necessary.

TABLE DIMENSIONS	ANGLE	WEIGHT	RETRACTABLE	WORK SURFACE	CLAMPING	ACCESSORIES
76"H x 110"W x 30"D (1900mm)H x (2800mm)W x (7600mm)D	30° from vertical	350 lbs. (160kg)	Retracts out of the way for frames longer than 8' (2.4m)	4' (1.2m) x 8' (2.4m) melamine, 1 1/8" (28mm)-thick	Four high-quality clamping cylinders can be independently controlled. Activate one at a time or all at once with a master switch.	Add our Pneumatic Screw Gun and 8' (2.4m) Coil Hose

ACCESSORIES



ITEM# CT6080

PNEUMATIC SCREW GUN & 8' (2.4M) POLYURETHANE COIL HOSE

This heavy-duty industrial pneumatic screw gun is perfect for use with our 4' (1.2m) x 8' (2.4m) Face-Framing Table. It features a variable-speed pneumatic motor that provides up to 1,800-RPM at an average of 16-CFM, and durable construction for even the most high-production environments.

CUTTING

ADAPTIVE CUTTING SYSTEM	24-27
CIRCULAR SAW CUTTING	28-33
BAND SAW CUTTING	34
MITER SAW CUTTING	35-37

QUALITY PROJECTS START WITH QUALITY CUTS

Kreg® cutting solutions make it easy to get the straight, accurate cuts you need to create quality projects. They transform your circular saw, miter saw, band saw, table saw, or jigsaw into a precision cutting tool that delivers accurate, repeatable results every time.



ADAPTIVE CUTTING SYSTEM

Guided cutting is quickly becoming the new standard for breaking down boards and plywood. This method uses a precision guide track to ensure the saw follows your cutline exactly. With guided cutting, you'll discover it's possible to get high-quality results with straight, smooth cuts and minimal tearout.

You'll also find that you no longer have to worry about the inaccuracies and lack of control that come with freehand circular-saw cutting, or the risks that come from a table saw, like working around an exposed blade, watching out for kickback, or maintaining control over materials. With guided cutting, you are in control.

With the Adaptive Cutting System, instead of worrying about the quality of your cuts, you can concentrate on your craft, confident that you'll get great results. Whether you're using the Plunge Saw and Guide Track alone or you've paired them with the Project Table to create an even-more capable cutting system, you'll get great cutting results using one integrated system instead of several different saws.



VERSATILE

Cut plywood and boards with one system - whether you need rip cuts, crosscuts, miter cuts, or angled cuts.



SAFE

Work confidently with anti-kickback features and an enclosed blade that help protect you from close calls.



PRECISE

Make accurate, high-quality cuts with ease and repeatability.



PORTABLE

Set up and stow your system quickly for simple storage and transport.



FEATURES

VERSATILE

You take pride in your ability to build things with your own hands—from furniture to home organizers to projects for your garage and shop. If you can build it from wood, you're ready to take it on. That's why you need a system that can handle all your cutting needs in the plywood, hardwood, and dimensional lumber you use. That's why you need the Adaptive Cutting System.

- Crosscut solid wood
- Rip boards
- Cut plywood
- Cut perfect angles



PRECISE

You know that great projects start with great cuts. With the Adaptive Cutting System, you can make cuts in plywood and solid wood that are dead-on accurate and super straight, with smooth edges that are free from tearout. The Guide Track positions the high-performance Plunge Saw precisely while the system's cutting guides and integrated measuring abilities ensure easy-to-achieve precision — whether you're cutting on the Project Table or off it — so you can concentrate on your craft instead of worrying about the quality of your cuts.

- Cut straight
- Cut Perfect angles
- Minimize tearout
- Make repeatable cuts
- Set accurate measurements



SAFE

The Adaptive Cutting System is packed with safety features, like a fully-shrouded blade, an electronic brake, anti-kickback protection, and a blade-left design that keeps your hands well away from the blade (just to name a few). Add in the sturdy support of the Project Table for workpieces large or small — plus the Guide Track and cutting guides that position and securely hold everything while you cut — and you'll be cutting with confidence.

- Eliminate kickback
- Protect your hands
- Support big, heavy material
- Position workpieces securely

PORTABLE

You'd love to have a dedicated space where all your tools could be set up and ready to go any time. But your workspace also serves other duties, and sometimes you need to take the tools to the work, rather than taking the work to the tools. The Adaptive Cutting System is portable, so you can set it up quickly and be ready to work in minutes. Then stow it away compactly when you're using your workspace for other things.

- Work where you want to
- Be ready to work in minutes
- Stow it compactly away



BUILD YOUR OWN SYSTEM

ADAPTIVE CUTTING SYSTEM MASTER KIT

The Adaptive Cutting System Master Kit includes the Plunge Saw, 62" Guide Track, Project Table Top, and Project Table Base, giving you a cutting system that can adapt to your needs, whether you're crosscutting boards to length, ripping them to width, cutting mitered angles, or even cutting plywood sheets and large panels down to size. The Adaptive Cutting System makes it all possible, and more, by combining the advantages of guided cutting with the unparalleled versatility of a Project Table that supports and positions materials precisely.



INCLUDES

- (1) Plunge Saw
- (1) 62" Guide Track
- (1) Project Table Top
- (1) Project Table Base
- (4) Versa-Stops
- (1) 48" Extension
- (1) Miter Guide
- (2) Repetitive Stops
- (1) Bridge

SAW + GUIDE TRACK KIT ITEM# ACS2000

This kit includes the Adaptive Cutting System Plunge Saw and the 62" Guide Track to make straight, accurate, smooth, and splinter-free cuts in plywood, other sheet goods, and in solid-wood boards. The Saw + Guide Track Kit provides unparalleled control with a cutting capacity up to 50". Simply lay the 62" Guide Track where you want to cut. It stays in place without clamps while the Plunge Saw cuts up to 2 1/8" deep at 90° and 1 1/2" at 45°. Safety is ensured with features that protect against binding and kickback, so you can cut with confidence.



Plunge Saw: ACS-SAW
Guide Track: ACS430



Project Table Top: ACS-TTOP
Project Table Base: ACS-TBASE

PROJECT TABLE KIT ITEM# ACS1000

This kit provides a sturdy, high-performance 55" x 29 3/4" table with included guides, stops, and integrated measuring scales, plus a heavy-duty steel base. The base folds to stand the table up vertically so it can easily be rolled and stowed when not in use, or easily transported to where you want to work. Simply install the Adaptive Cutting System 62" Guide Track on the Project Table to create an all-in-one cutting system.

ADAPTIVE CUTTING SYSTEM ACCESSORIES



RIP GUIDES

ITEM# ACS405

Rip Guides attach easily to the Adaptive Cutting System 62" Guide Track to provide accurate measurement and repeatable results when making cuts up to 13" wide in solid wood, plywood, and other sheet goods. Rip Guides also eliminate potential inaccuracies of measuring and marking every cut.



PARALLEL GUIDES

ITEM# ACS415

Parallel Guides attach easily to the Adaptive Cutting System 62" Guide Track to provide accurate measurement and repeatable results when cutting from 12" to 96" wide in solid wood, plywood, and other sheet goods. Parallel Guides also eliminate potential inaccuracies of measuring and marking every cut.



62" GUIDE TRACK

ITEM# ACS430

The 62" Guide Track guides the Plunge Saw for straight, splinter-free cuts in solid wood and plywood. An Anti-Chip Strip prevents splintering, while Anti-Slip Strips to hold the track in place. Can be used alone for 50" off-table cutting capacity, or paired with a second track for 112" off-table capacity.

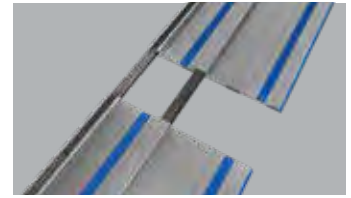

GUIDE TRACK CONNECTORS

ITEM# ACS445

Connect two 62" Guide Tracks together for extended cutting capacity up to 112". These steel connectors have a two-piece design that prevents marring the aluminum tracks. Designed for use with the Adaptive Cutting System 62" Guide Track. Sold as a pair.



EXTENSION BRACKETS

ITEM# ACS440

Add more workpiece support to the Project Table for full sheets of plywood or long boards. This pair of brackets mounts in the aluminum perimeter frame of the Project Table and accept 2x4 boards that can be supported at the other end by a Kreg® Track Horse, Mobile Project Center, or another work support.

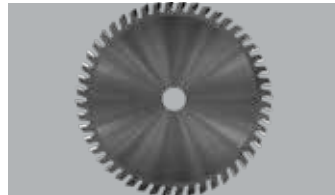

48-TOOTH SAW BLADE

ITEM# ACS705

This saw blade is designed to deliver optimum cutting performance for the Adaptive Cutting System Plunge Saw. A laser-cut body with anti-vibration slots and 48 carbide teeth ensure smooth cutting. 6 1/2" (165mm) diameter blade has a 20mm arbor hole for compatibility with the Plunge Saw. Cuts a 2.2mm-wide kerf.

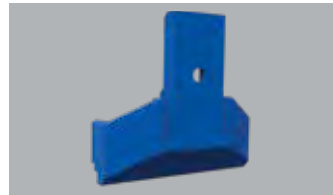

SPLINTER GUARD

ITEM# ACS735

The Splinter Guard mounts in the Plunge Saw shroud and fits tight against the blade on the side not touching the Guide Track. This ensures splinter-free cuts on both sides of the blade. Replacing the Splinter Guard restores splinter-free cutting on this side of the saw blade. Sold as a set of three. Includes mounting screws.

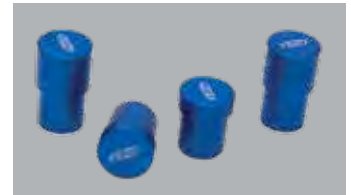

VERSA-STOPS

ITEM# ACS435

Versa-Stops fit into holes in the Adaptive Cutting System Project Table to hold workpieces, and to position them precisely for 90° and 45° cuts. Sold as a set of four (two tall, two short). Also included with the Project Table Top. Can be used as bench dogs in any bench with 3/4"-diameter dog holes.

REPLACEMENT PARTS

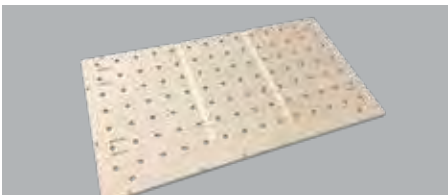

PROJECT TABLE REPLACEMENT TOP

ITEM# ACS745

Replace a worn or damaged table surface on the Project Table without buying a complete new top. This MDF Replacement Top is machined to the same precision as the original. Includes mounting hardware and instructions.

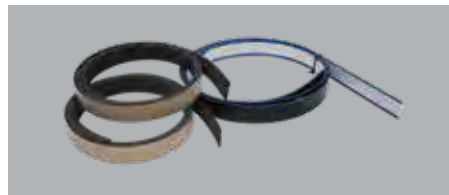

ANTI-CHIP STRIP + FOAM STRIPS

ITEM# ACS715

Replace worn Anti-Chip Strips or Anti-Slip Strips on your 62" Guide Track with fresh, new versions. These strips are just like the ones that come on the track. Includes one Anti-Chip Strip and two Anti-Slip Strips.

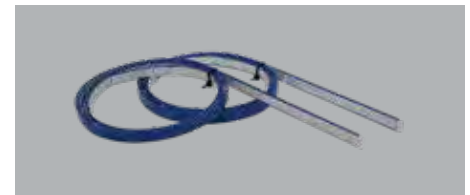

GLIDE STRIPS

ITEM# ACS725

Replace worn or damaged Glide Strips on the upper surface of your Adaptive Cutting System 62" Guide Track with new strips to restore smooth saw gliding. These strips are just like the ones that come on the track. Includes two Glide Strips.

CROSSCUT STATION

The Crosscut Station delivers the capabilities of a miter saw with just a circular saw. Crosscut boards wider than most compound miter saws can handle (up to 12" at 90°). Make a variety of angle and miter cuts from 0° to 45° with the Adjustable Fence.

An MDF base and SureCut™ backboard act as a sacrificial surface for splinter-free cutting results. The MDF base also functions as a kerf line to clearly show the blade's path.

Use material support wings and the detachable blocks to cut long boards safely by supporting offcuts. They pull out easily when more support is needed, and tuck back in when not in use. The Crosscut Station is quick to set up and easy to store away. Its compact design even makes it portable for accurate crosscuts and angle cuts on the go.



ITEM# KMA4100



HIGH-PERFORMANCE

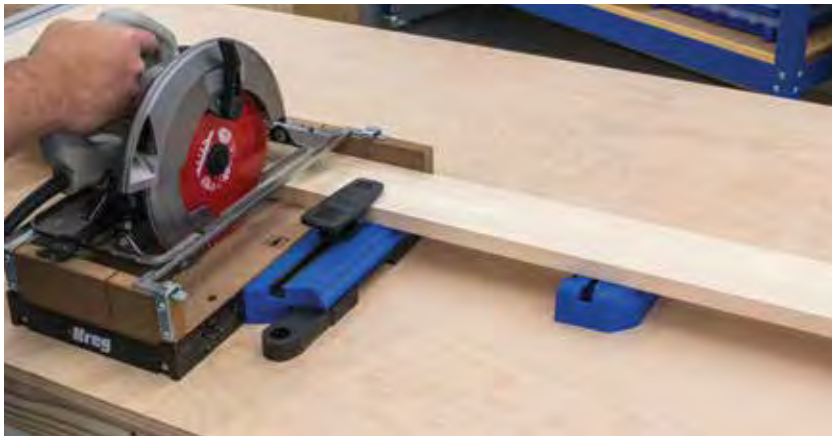

INCLUDES

- Crosscut Station with Guide Rails
- Built-in Material Hold-Down Clamps
- Adjustable Fence

Crosscut up to 12" wide and make a variety of miter cuts from 0° to 45°

FEATURES



MDF base and backboard act as sacrificial surface for splinter-free cutting



Material support wings with detachable blocks add material support for long pieces



A kerf line you cut into the MDF base shows exactly where your saw will cut



Works with left- or right-blade circular saws



PORTABLE CROSSCUT

ITEM# KMA4000

The Portable Crosscut allows you to quickly and precisely crosscut boards up to 8" wide and make accurate cuts at a 45° angle using just a circular saw. See exactly where the saw will cut every time thanks to the retractable cutline indicators. Simply align them to a pencil mark and cut with confidence.

The saw support ledge starts off every cut with stability and precision, while GripMaxx™ holds the guide steady throughout the entire cut. It's all part of the guided cutting advantage that delivers high-quality cuts using only a guide and a circular saw. With the Portable Crosscut, set up cuts in no time and get to work quickly.



ADD SPEED AND ACCURACY TO YOUR CIRCULAR SAW



Quickly and accurately crosscut up to 8" (203mm) wide



Also makes precise 45° cuts



Take the guide anywhere your projects take you



Cutline indicators show exactly where your saw will cut

STRAIGHT EDGE GUIDE

Cut sheet goods down to size with precision and ease by using the Kreg® Straight Edge Guide. Work with material up to 4 feet and get the cuts you need – using a circular saw, jigsaw, or even a trim router. Guided cutting makes it easier than ever to see exactly where the saw will cut to deliver accurate results every time.

Align cuts quickly and precisely with the cutline indicators. Secure the guide to the material using low-profile GripMaxx™ clamps that are built right into the guide. Then simply make a cut.



INCLUDES

- (2) 28" Guide Rails
- (2) Paired Connector Bars
- (2) Cutline Indicator Arms
- Adjustable GripMaxx™ Clamp Handle



Aluminum guide rail leads cuts precisely along a straight line



Works with left- and right-blade circular saws, as well as jigsaws and trim routers

STRAIGHT EDGE GUIDE XL

Cut full sheets of plywood down to size with precision and ease by using the Kreg® Straight Edge Guide XL. Work with material up to 8 feet using a circular saw, jigsaw, or even a trim router. Guided cutting makes it easier than ever to see exactly where the saw will cut to deliver accurate results every time.



Aluminum guide rail leads cuts precisely along a straight line



Crosscut and rip cut material up to 8 feet



INCLUDES

- (2) 28" Guide Rails
- (2) 24" Guide Rails
- (6) Paired Connector Bars
- (2) Cutline Indicator Arms
- Adjustable GripMaxx™ Clamp Handle

STRAIGHT EDGE GUIDE EXTENSION

Add two extra feet to the Kreg® Straight Edge Guide to make even longer cuts in sheet goods with most circular saws, jigsaws, and trim routers.

INCLUDES

- 24" Guide Rail
- (2) Paired Connector Bars



Add 2 feet (61cm) to your Straight Edge Guide to crosscut and rip cut sheet goods

RIP-CUT™

The Rip-Cut™ turns your circular saw into a precision edge-guided cutting tool that makes straight, accurate, repeatable cuts in plywood and other large sheets. With the Rip-Cut, you don't have to measure, mark, or struggle to keep the saw on the cut line, thanks to a long edge guide that follows the edge of the sheet. Just lock the saw in at the measurement you want—up to 24" (610 mm)—using the built-in measuring scale, and then make your cut.

Simply mount your saw to the Universal Sled—it accepts most left- or right-blade saws—and then slide the sled onto the aluminum rail. The edge guide is reversible for use whether you're left- or right-handed. The Rip-Cut™ is an easy, accurate, and affordable way to cut plywood and sheets down to size.



Make cuts wherever you want to by taking your saw to the workpiece rather than taking your workpiece to the saw.

INCLUDES

- (1) Universal Saw Sled
- (1) Aluminum Guide Rail
- (1) Precision Edge Guide
- (1) Owner's Manual

SPECS

- Aluminum & impact-resistant polymer construction
- Guide Rail locks in the measurement on a built-in scale
- Accepts left- & right-blade saws
- Has built-in index stop & precision cursor
- Cut widths up to 24"



No measuring or marking required thanks to a built-in measuring scale and precision cursor. Just lock in your cut size, and go.



Easy repeatability lets you make multiple parts of the same size, and eliminate errors caused by incorrectly sized parts.



Make quick, accurate adjustments by simply sliding the saw sled along the rail, and then locking it down. No tools necessary. The sled also works with the Accu-Cut™



Straight cuts are easy thanks to an oversized edge guide with a hand-hold that provides control through the entire cut by following the edge of your sheet.

ACCU-CUT™

The Accu-Cut™ allows you to make straight, accurate, splinter-free cuts with your circular saw. It rips and crosscuts up to 50" long in plywood, MDF, and panels with amazing control. The Accu-Cut guides your circular saw along an aluminum track that keeps the saw moving in a straight line, and it makes setup easy by just aligning the track with your cut line. Anti-Chip and Anti-Slip Guide Strips hold the track in place without clamps, and support the wood fibers to prevent splintered cuts.

Simply mount your saw to the Universal Sled—it accepts most left-blade or right-blade saws. Set the sled on the track, and you're ready to cut. Because the Accu-Cut™ is portable, you can take your saw to the workpiece and cut with precision, rather than having to handle heavy sheets on a table saw. Optional Track Clamps can be used with slick materials such as melamine or pre-finished plywood.



Take your projects to the next level with more precision from your circular saw than you ever thought possible.



A Starting Block in the Accu-Cut™ track aligns and supports your saw to ensure that you can start every cut accurately. Plus, the Starting Block allows normal blade-guard operation to ensure safety as you start each cut, and helps guide the saw cord while cutting.



The Accu-Cut™ sled attaches easily to your circular saw, and accepts most left- or right-blade saws. A stop ensures repeatable alignment, so you can remove the saw from the sled for freehand cutting, and then reinstall it on the sled quickly and easily. This sled also works with the Rip-Cut™



Eliminate the guesswork by simply aligning the track with your reference marks. Guide Strips on each edge of the Accu-Cut™ show you exactly where your saw will cut, so you can make every cut with confidence.



The track stays in place on your marks thanks to an anti-slip, anti-chip surface on the underside of the Guide Track, so no clamps are needed for most cuts. Optional clamps (below) are available for use on materials with a slick surface, melamine or pre-finished plywood.

INCLUDES

- (1) Universal Saw Sled
- (1) Starting Block
- (2) 26.5" Aluminum Track Sections
- (2) Aluminum Connectors with Set Screws
- (4) Anti-Chip and Anti-Slip Guide Strips
- (1) Owner's Manual

SPECS

- Aluminum & impact-resistant polymer construction
- Anti-Chip, Anti-Slip Guide Strips
- Universal Saw accepts left- and right-blade saws
- Starting Block aligns saw at start of cut
- Cut length up to 50"



ITEM# KMA2700

ACCU-CUT™ EXPANSION PACK

Double the cutting capacity of your Accu-Cut™ with the Accu-Cut Expansion Pack. It connects easily to your Accu-Cut to deliver the same straight, accurate, splinter-free performance on cuts up to 100" long.

INCLUDES

- (2) 26.5" Aluminum Track Sections
- (6) Steel Track Connectors with Set Screws
- (8) Anti-Chip & Anti-Slip Guide Strips
- (1) Owner's Manual

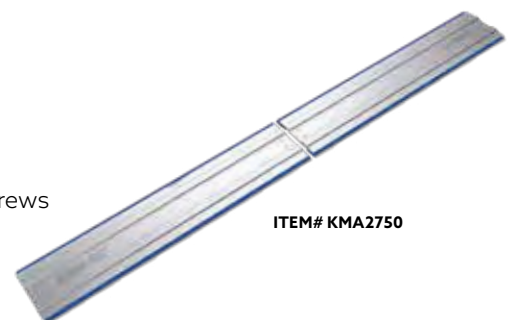

ITEM# KMA2750

ACCU-CUT™ XL

Transform your circular saw into a high-performance track-guided cutting tool for breaking down full sheets of plywood. Set your projects up for success by making straight, accurate, splinter-free cuts with the Accu-Cut™ XL Circular Saw Track Guide. It rips and crosscuts up to 100" long in plywood, MDF, and other large panels with accuracy and control.

The Accu-Cut™ XL guides your circular saw along an extended-length aluminum track that holds the saw steady and keeps your cuts straight. The track guide is designed for simplicity: just mount your saw to the Universal Sled, align the Accu-Cut XL track to the cut line, and make the high-quality cuts you need. The Anti-Chip Guide Strips prevent splintering and tearout through the entire length of your cut. The same strips also feature an Anti-Slip surface that holds the track in place without clamps.



ITEM# KMA3700

INCLUDES

- (1) Universal Saw Sled
- (1) Starting Block
- (4) 26.5" Aluminum Track Sections
- (6) Steel Track Connectors with Set Screws
- (8) Anti-Chip and Anti-Slip Guide Strips
- (1) Owner's Manual

SPECS

- Aluminum & impact-resistant polymer construction
- Anti-Chip, Anti-Slip Guide Strips
- Universal Saw accepts left- & right-blade saws
- Starting Block aligns saw at start of cut
- Cut length up to 100"

HIGH-PERFORMANCE TRACK-GUIDED CUTTING

The Accu-Cut™ XL turns your circular saw into a precision cutting tool to make straight, accurate, splinter-free cuts. The extended-length track allows cuts up to 100" long in panels and plywood. The track is lined with Anti-Chip, Anti-Slip Guide Strips that prevent splintering and tearout while holding the track in place without clamps.

CROWN-PRO™

Installing crown molding is one of the best ways to add instant value to your home. The Crown-Pro™ simplifies the most frustrating steps of the process, so you minimize mistakes and get the job done faster. This unique tool holds your trim at the exact angle required, eliminating the need for advanced compound miter cuts and difficult "coping." Its design lets you compensate for a wide variety of crown molding spring angles, and extension arms lets you work with crown up to 5 1/2" (140mm) wide.

SIMPLE STEPS TO PERFECT CROWN:



MAKE YOUR CUTS

Position your Crown-Pro™ on either side of your saw based on the type of joint, and then make the cut.



INSTALL YOUR CROWN

Position your crown on the wall and nail it securely into place. You'll get perfect results with the Crown-Pro™



ITEM# KMA2800

INCLUDES

- (1) Crown-Pro™
- (1) Double-Sided Angle Finder
- (8) Non-Slip Rubber Feet
- (1) Owner's Manual

SPECS

- Size: 3.14" x 14.94" x 4.17"
- Workpiece width: 5 1/2" with 12" saw, 3 1/2" with 10" saw
- Spring angle range: 30°- 65°

PRECISION BAND SAW FENCE

Most band saw blades don't run perfectly perpendicular to the front of your table. There's always just a little bit of "drift" that prevents you from getting precise cuts, even with a fence. The Precision Band Saw Fence easily adjusts to your blade's drift angle to provide you with a new level of band saw accuracy. This fence mounts to most 14" (355mm) band saws right out of the box, and can be modified to fit many others by drilling a single hole in the aluminum mounting rail.



SPECS

- Anodized aluminum construction
- Precision lens cursor for accurate cuts
- Mounting rail: 26" long
- Easy adjustments for squareness to the table and for blade drift
- Fence: 18" long
- Pre-drilled holes fit most 14" band saws

EXACT ALIGNMENT



Set the fence exactly square with your table surface, and adjust the angle to compensate for blade drift easily with set screws that adjust simply and hold securely for dependable results.

EASY TO REMOVE



Remove the fence in seconds, with no tools required! Just loosen the locking knob and lift the fence from the mounting rail. The rail sits out of the way below the table surface.

RIGID DESIGN



The aluminum fence is incredibly strong, straight, and built to last for years. The face and top edge of the fence contain T-slots for adding stops, resaw guides, and more.

TWO-POSITION FENCE

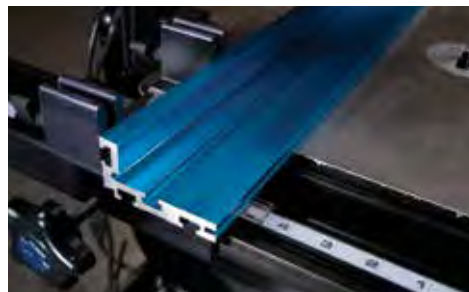

Quickly and easily switch from a tall fence to a low fence for cutting thin pieces without throwing off squareness or blade drift settings. The switch back just as easily.

PRECISION LENS CURSOR



Magnified and easy-to-read for even the smallest adjustments, the Precision Lens Cursor lets you accurately set up the fence for cutting veneer, tenons, and more.

ACCEPTS A STOP



Add a Swing Stop™ or a Production Stop to the fence to simplify making accurate, repeatable cuts to a set depth, such as when cutting tenons.

ACCESSORIES

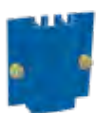

4.5" RESAW GUIDE
(114mm)

Adjust for blade drift as you resaw.

ITEM# KMS7213



7" RESAW GUIDE
(178mm)

Adjust for blade drift as you resaw wide workpieces.

ITEM# KMS7214



PRECISION MICRO-ADJUSTER

Add enhanced precision to every cut.

ITEM# KMS7215

PRECISION MITER GAUGE

Why spend your time calibrating a miter gauge when you can get factory-calibrated accuracy right out of the box? Our Precision Miter Gauge requires no calibrating, and features positive stops at 0°, 10°, 22 ½°, 30° and 45°, making it easy to cut miters quickly.

When you want to cut at a different angle, the super-accurate, easy-to-use Vernier scale allows for fast adjustments to 1/10th of a degree.

You can choose the Precision Miter Gauge, or the Precision Miter Gauge System, which includes a 24" (610mm) fence and a Swing Stop™ (see Buying Options below).



SPECS

- Fence: 24", anodized aluminum construction
- Guide bar: 26" long, 3/8" thick by 3/4" wide
- Positive stops at: 0°, 10°, 22 ½°, 30° & 45°
- Factory calibrated

PERFECT MITERS, FAST!

Precision is the name of the game for this CNC-milled miter gauge. We build accuracy into every feature of this product from the adjustable miter bar to the easy-to-use, incredibly accurate Vernier scale. With all of its great features, this miter gauge will give you better, more accurate cuts to ensure project success.

FEATURES



PRECISION LENS CURSOR

Similar to the type of lens found on a quality table saw rip fence, the clear lens features a high-visibility red line that makes it easy to set the Swing Stop™ for precise cuts, time after time.



NO PLAY IN MITER SLOT

Our extremely straight 24" (610mm) anodized-aluminum bar is 3/8" (9.5mm) thick by 3/4" (19mm) wide and features five bar adjusters that eliminate "play" in the miter slot.



MULTIFUNCTION SWING STOP™

Adds repeatable accuracy to your Miter-Gauge Fence. This versatile Swing Stop™ holds your desired measurement precisely, and swings out of the way easily when you want to cut without it.



BUYING OPTIONS



PRECISION MITER GAUGE
Precision Miter Gauge only.

ITEM# KMS7101



PRECISION MITER GAUGE SYSTEM
Precision Miter Gauge, 24" (610mm) aluminum fence, and Swing Stop™

ITEM# KMS7102

PRECISION TRAK & STOP KIT

Take the guesswork—and your tape measure and pencil—out of cutting wood to length. Our Precision Trak and Stop Kit allows you to turn a miter saw into a precise cutting system. Simply position the stop at the dimensions you'd like to cut using the Precision Lens Cursor, place the board against the stop, and cut to that exact length every time. You build the support wings out of plywood (or another sheet material), and then add the Trak. The 2' (610mm) long Trak sections give you options. Includes four 2' (610mm) long sections that can be used on the right or left side of the saw, or split between both sides. Outfitting your saw to cut perfectly-sized workpieces couldn't be simpler!



INCLUDES

- (4) 2' pieces of Trak
- (1) Swing Stop™
- (1) Production Stop
- (1) 12' length of left-to-right reading self-adhesive tape
- (1) 12' length of right-to-left reading self-adhesive tape
- (1) Owner's Manual
- (1) Mounting Hardware

SPECS

- Anodized aluminum construction
- Can be configured in multiple ways
- Precision left-to-right and right-to-left measuring rules
- Swing Stop™ and Production Stop ensure accuracy, repeatability
- Detailed instructions show how to build a platform to fit your saw

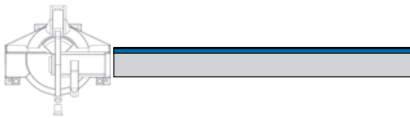

Position all 8 feet (2440mm) of Trak on one side.

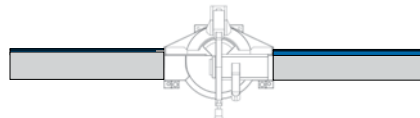

Center your saw with 4 feet (1220mm) of Trak on each side.

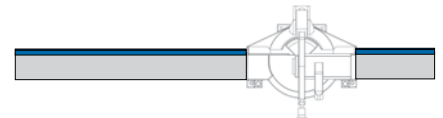

Place 6 feet (1830mm) of Trak on one side and 2 feet (610mm) on the other side.

PERFECT FOR A WIDE VARIETY OF APPLICATIONS

The most common setup for the Precision Trak & Stop Kit is with a miter saw. But, many people find it useful to add to their radial arm saw or drill press. No matter where you use the Precision Trak & Stop Kit, you'll find it far more accurate and much quicker than a tape measure and pencil.



PRODUCTION STOP

Designed to stand up to the rigors of repetitive cuts in an industrial environment, the Production Stop mounts onto the top of the fence and features dual lens cursors for convenient use on either side of the blade.

#KMS7800



SWING STOP™

The Swing Stop™ features bushings that reduce "play" in the stop to increase accuracy. The stop sets the distance between the end of the board and the blade for accuracy and repeatability, and flips out of the way when not in use.

#KMS7801



RIGID ALUMINUM FENCE

The anodized aluminum Trak features an L-shaped foot that makes alignment and mounting to any 3/4" (19mm) thick board a snap. Trak is designed with a groove across the top to accept the included self-adhesive measuring tape.



SIMPLE SUPPORT WINGS

Build simple plywood or MDF extensions to match the height of your saw, and then add a back fence that reaches 2 1/4" (57mm) above the saw base height. Instructions for building the wings and mounting hardware for the Trak is included.

PRECISION STOPS



PRODUCTION STOP

This heavy-duty, highly accurate stop is built for rugged use. Dual lens cursors allow for use on either side of the blade. The Production Stop fits on top of the Top Trak and Heavy-Duty Trak. Can be removed and repositioned easily.



SWING STOP™

Add repeatable accuracy to your miter saw, band saw, or table saw fence with this versatile Swing Stop.™ It holds your desired measurement precisely, and swings out of the way easily when you want to cut without it.

TRAK COMPONENTS



JIG AND FIXTURE BAR

This durable bar fits standard 3/4" x 3/8" miter slots. Eight nylon screws along the length of the bar adjust to take up any play in the slot. Mounting holes are located every 5" (127mm) along the length of the bar. Perfect for building workshop jigs and fixtures.

ITEM#KMS7303 **Jig & Fixture Bar (30" length) (762mm)**



HEAVY-DUTY TRAK

Our Heavy-Duty Trak is an L-shaped, anodized-aluminum extrusion that is extremely straight and perfect for heavy-duty commercial applications. Contains four T-slots that accommodate the head of a standard 1/4" (6mm) bolt.

ITEM#KMS7704 **Heavy-Duty Trak (48" length) (1219mm)**



COMBO-TRAK

Building your own router table? This combination Miter-Trak and Mini-Trak works with your miter gauge, featherboards, and other accessories to add flexibility to your table top.

ITEM#KMS7448 **Combo-Trak (48" length) (1219mm)**



TOP TRAK

This track features a self-aligning L-shaped mounting foot for easy installation to a shop-made fence. Just drill 1/8" (3mm) holes through the back of the extrusion and secure with the included mounting screws.

ITEM#KMS7712 **Top Trak (24" length) (610mm)**
ITEM#KMS7714 **Top Trak (48" length) (1219mm)**



TRACK CLAMPS

Track Clamps have a T-bolt that fits the Accu-Cut™ Adaptive Cutting System 62" Guide Track, Mini Trak, Top Trak, HD Trak, Clamp Trak, and Mobile Project Center. Great for making jigs and fixtures. Sold as a pair, hardware included.

ITEM#KMS7520 **Track Clamps**



MINI TRAK 48" (1219MM)

Mini Trak can be used to produce countless types of woodshop jigs and fixtures such as taper jigs and cut-off sleds. An adaptation of our other popular styles of Trak, Mini Trak features a T-slot that captures the head of a standard 1/4" (6mm) hex bolt.

ITEM#KMS7509 **Mini-Trak (48" length) (1219mm)**

CLAMPING

CLAMPS	40-45
CLAMP ACCESSORIES	46-47

THE HELPING HAND YOU NEED TO MAKE PROJECT BUILDING EASIER

Kreg Clamping Solutions provide versatile, powerful ways to hold your projects whether you are cutting, joining, sanding, or assembling.

Available in a variety of styles and sizes to suit your needs, most feature Automaxx® Auto-Adjust Technology that adjusts the clamps automatically to match the material you need to hold.

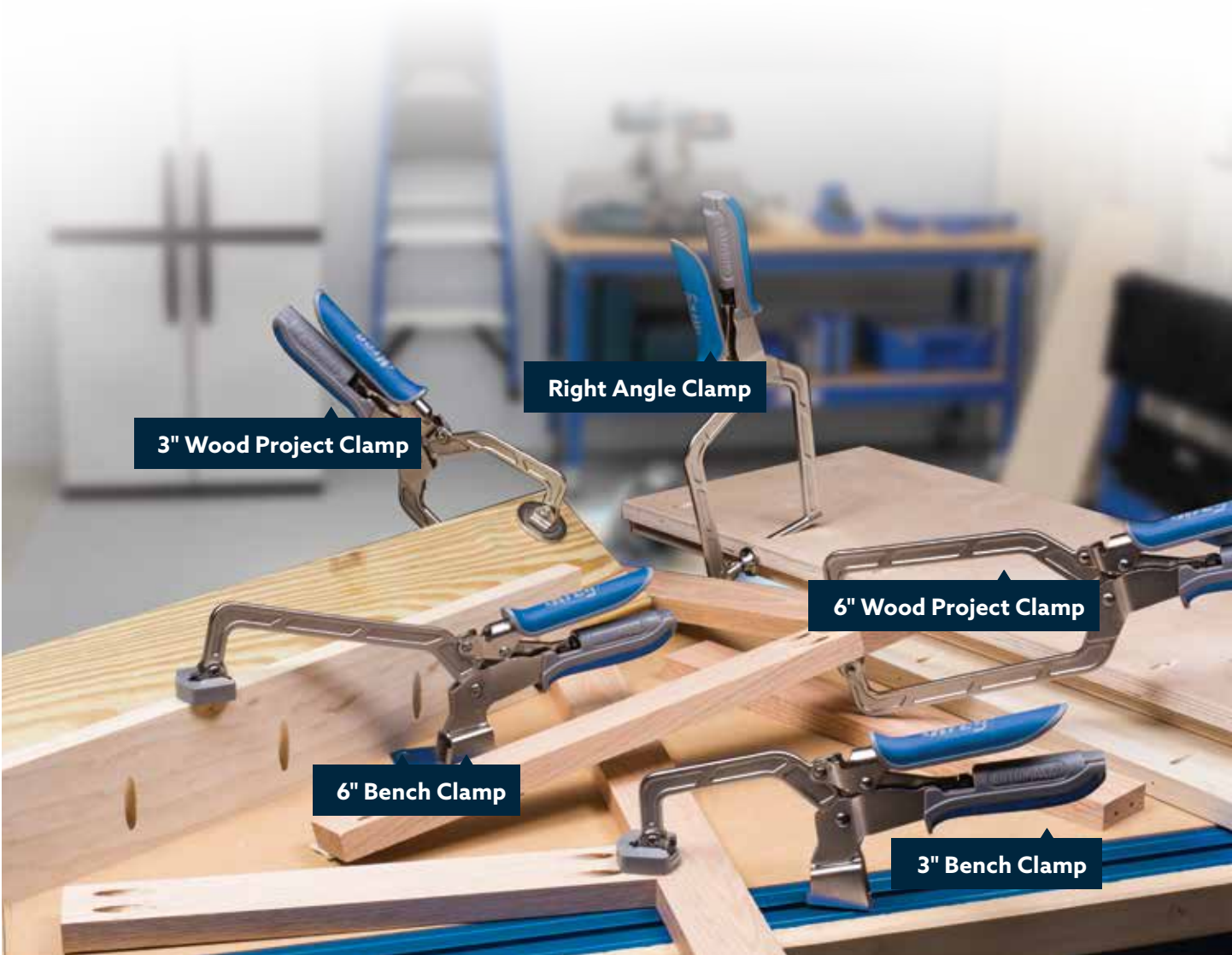

3" Wood Project Clamp

Right Angle Clamp

6" Wood Project Clamp

6" Bench Clamp

3" Bench Clamp

AUTOMAXX[®]

AUTO-ADJUST TECHNOLOGY

Automaxx[®] Technology makes clamping fast and foolproof by adjusting the clamp automatically to match the material thickness. Whether it's thick, thin, or in between, Automaxx[®] holds every time with the clamping pressure you set.



CLAMP THICK



CLAMP THIN



OR IN BETWEEN...

WITHOUT READJUSTING THE CLAMP!

WOOD PROJECT CLAMPS

Wood Project Clamps are perfect for Kreg Joinery,[™] project assembly, general clamping, and more. Available in two sizes—3" (76mm) reach and 6" (152mm) reach—these versatile clamps have large clamp faces that distribute clamping force evenly and won't mar delicate surfaces. They are compatible with the 300-Series Pocket-Hole Jig Universal Clamp Adapter and the Kreg Portable Base.

Thanks to Automaxx[®] Auto-Adjust Technology, Wood Project Clamps adjust to match material thickness automatically with a simple squeeze of the handles—whether the material is thick, thin, or in between. These clamps also feature easy-to-regulate clamping pressure with a simple thumbscrew.



AUTOMAXX[®]

WOOD PROJECT CLAMP

3" (76mm) reach, 3" (76mm) capacity. This easy-to-use, compact clamp fits easily into tight spaces.



ITEM #KHC3

WOOD PROJECT CLAMP

6" (152mm) reach, 5" (127mm) capacity. Offers increased reach and clamping capacity for larger items.



ITEM #KHC6

BENCH CLAMPS

Bench Clamps offer the perfect solution for benchtop clamping. These versatile clamps are perfect for creating flush-fitting assemblies with Kreg Joinery,[™] and they're great for project assembly, routing, cutting, sanding, drilling, and more. Bench Clamps work with Clamp Trak, Bench Clamp Base, the Clamp Table, Mobile Project Center, and more to secure workpieces using an extra-large padded clamp face that evenly distributes clamping force.

Thanks to Automaxx[®] Auto-Adjust Technology, Bench Clamps adjust to match material thickness automatically with a simple squeeze of the handles—whether the material is thick, thin, or in between. These clamps also feature easy-to-regulate clamping pressure with a simple thumbscrew.



AUTOMAXX[®]

BENCH CLAMP

3" (76mm) reach
3 1/2" (89mm) capacity



ITEM #KBC3

BENCH CLAMP

6" (152mm) reach
5" (127mm) capacity



ITEM #KBC6

90° CORNER CLAMP

AUTOMAXX

The Kreg® 90° Corner Clamp makes it easier than ever to successfully assemble boxes, cabinets, drawers, and cases by giving you the extra hand you need to hold these assemblies at perfect 90° angles. This handy clamp makes alignment of the project parts easy, while Kreg Automaxx® Technology makes clamp operation fast and foolproof. When you are assembling projects using Kreg Joinery™, the Kreg 90° Corner Clamp offers the fastest, easiest-to-use corner clamp you can buy.

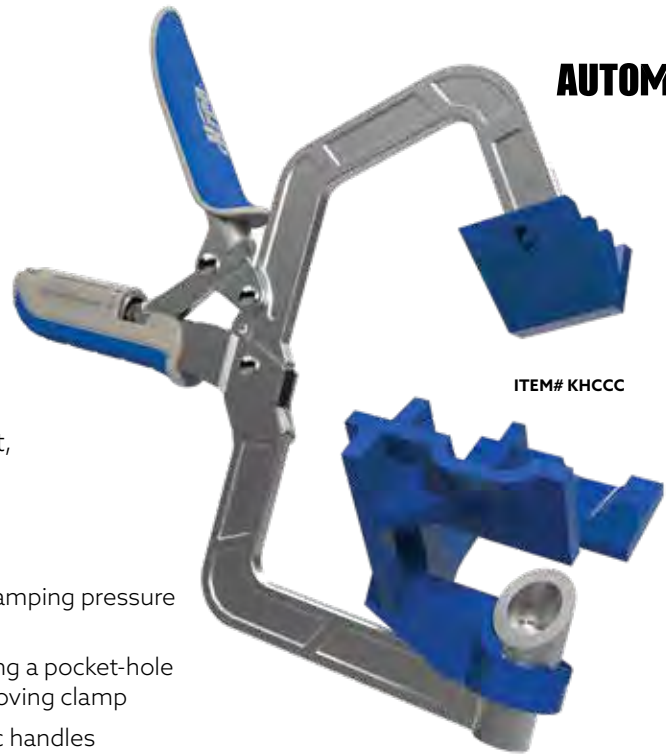

SPECS

- Works on 90° corners and "T" joints
- Cast aluminum "V" and wedge pads
- 1" maximum thickness capacity
- Automaxx® auto-adjust technology
- Easy-to-regulate clamping pressure with thumbscrew
- Cutout allows driving a pocket-hole screw without removing clamp
- Padded, ergonomic handles



THE EASY WAY TO HOLD 90° CORNER JOINTS & "T" JOINTS

Get the helping hand you need to hold 90° corners and "T" joints together securely when you're assembling boxes, drawers, cabinets and cases. The 90° Corner Clamp leaves both of your hands free to add your fasteners as you assemble your projects using Kreg Joinery.™

FEATURES



ADJUSTABLE

Easy-to-regulate clamp pressure provides appropriate pressure for all materials and assemblies.



PRECISE

Cast-aluminum "V" wedge clamp pads hold pieces at true 90° angles and help ensure edge alignment during assembly.



VERSATILE

Clamp jaw design securely holds corner and "T" joints at 90° angles, which leaves your hands free to work while the assembly stays together.



EASY-TO-USE

Automaxx® technology adjusts automatically to material thickness—up to 1"—and maintains clamping pressure

BENCH CLAMP WITH BENCH CLAMP BASE

This handy kit contains a 3" (76mm) Kreg® Bench Clamp and a Bench Clamp Base together. The clamp is equipped with Kreg Automaxx® technology, so all you have to do is attach the base to your work surface, insert the clamp, and then squeeze the clamp handles. The clamp adjusts to match the thickness of your workpiece—up to 3 1/2" (89mm).

INCLUDES

- (1) 3" (76mm) Bench Clamp with Automaxx®
- (1) Bench Clamp Base

AUTOMAXX®

ITEM #KBC3-BAS



Steel clamp and cast aluminum base hold large pieces in place securely.



Bench Clamp keeps pieces perfectly aligned to create tight-fitting joints.



Versatile design provides clamping capability for a wide variety of tasks.



Movable base is easy to position wherever needed on your work surface.

BENCH CLAMP BASE

Bring the power and convenience of Kreg Bench Clamps to any work surface, and create a versatile clamping station almost anywhere. The Bench Clamp Base is a perfect companion to the Kreg Mobile Project Center, and it allows you to get more from any work surface with 3/4" or 20mm bench dog holes. Or drill a hole in any work surface to easily attach the Bench Clamp Base, and just as easily remove it when not in use, or to move it.

FEATURES

- Cast aluminum base
- Heavy-duty 1/2" anchor bolt
- Easy-to-grip knob
- Works with all Kreg Bench Clamps—from earliest versions to current Automaxx® models
- Movable to allow use on more than one work surface
- Includes base, knob, hardware, and instructions



ITEM #KBCBA

AUTOMAXX®

AUTO-ADJUST BAR CLAMPS

When you want the durability and auto-adjust convenience of Automaxx® clamping, but you need more clamping capacity, turn to Auto-Adjust Bar Clamps with Automaxx® Technology. Just like other Kreg Clamps, these bar clamps adjust automatically when you change material sizes.

Just slide the clamp jaws against your workpiece, and then squeeze the handles. Automaxx® Technology does the rest, closing the clamp with predictable, dependable clamping pressure every time. That clamping pressure is easy to regulate, as well, thanks to a simple thumbscrew that dials in the pressure you need, from gentle to highly powerful clamping.

Auto-Adjust Bar Clamps are available in three lengths—8", 16", 24"—to suit a variety of project needs. Whether the job requires holding large pieces during assembly, keeping workpieces in place on your bench, or any number of other project processes, Auto-Adjust Bar Clamps are up to the task.

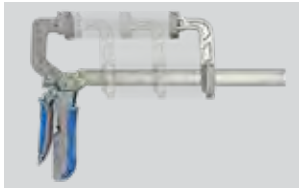

Sliding clamp jaw moves to any position on bar.

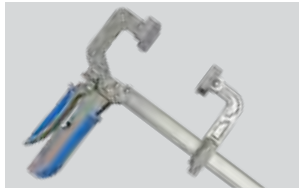

Available in three different capacities to match your needs.



Padded jaws grip securely without marring.

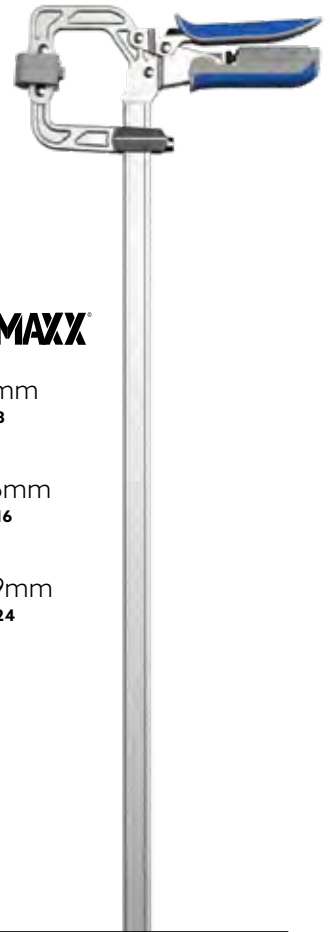

AUTOMAXX®

8" (203mm)
ITEM# KSC8

16" (406mm)
ITEM# KSC16

24" (609mm)
ITEM# KSC24

CLAMP VISE

Thanks to Automaxx® Auto-Adjust Technology, the Bench Clamp adjusts to match the material automatically with a simple squeeze of the handles—whether the material is thick, thin, or in between. The clamp allows easy regulation of clamping pressure with a simple thumbscrew.

INCLUDES

- (1) Bench Clamp with Automaxx®
- (1) Clamp Vise™ Plate
- (2) Clamp Blocks™
- (2) Bench Dogs with Bench Brakes
- (1) Mounting Hardware
- (1) Instructions



ITEM# KBC3-VISE

AUTOMAXX®

RIGHT ANGLE CLAMP

The Right Angle Clamp makes projects with 90° joints faster and easier by giving you the helping hand you need to hold the parts in position during assembly. Just slip the pin on the Right Angle Clamp into a pocket hole, close the clamp, and it draws the mating pieces tightly together. The swiveling clamp pad grabs the mating piece securely.

Automaxx® Auto-Adjust Technology adjusts the Right Angle Clamp to match the material automatically with a simple squeeze of the handles. Designed for use with standard-size Kreg® pocket holes only. Not compatible with Micro-Pocket™ holes.



ITEM# KHCRA

AUTOMAXX®

BENCH CLAMP WITH HEAVY-DUTY CLAMP PLATE

AUTOMAXX®

For versatile clamping on the go, check out the Heavy-Duty Bench Clamp System. It combines a 3" (76mm) Bench Clamp with a thick 10" x 10" (254mm x 254mm) powder-coated steel plate. The clamp is equipped with Kreg Automaxx® technology, so all you have to do is set the base where you want it (rubber feet keep it in place), insert the clamp, and then squeeze the clamp handles. The clamp adjusts to match the thickness of your workpiece—up to 3 1/2" (89mm).

INCLUDES

- (1) 3" Bench Clamp with Automaxx®
- (1) 1/4" x 10" x 10" Powder-Coated Steel Plate
- (4) Rubber Feet

ITEM #KBC3-HDSYS



IN-LINE CLAMP

By applying pressure from the side, the In-Line Clamp stays out of the way as you work. A peg fits into any 3/4" - diameter hole holds the clamp in place, so this clamp makes it possible to get more from any bench with dog holes—or any work surface where you can drill holes. The In-Line Clamp also makes a perfect companion to the Mobile Project Center.

Get the helping hand you need, when you need it, with the versatility and power you want for a wide variety of do-it-yourself and woodworking tasks from sanding to glue-ups, sanding painting and finishing, routing, project assembly, and more. This clamp applies up to 250 lbs. of clamping force, and swivels to clamp from any angle on almost any shape workpiece.



Low-profile design keeps clamp out of the way while working.



Clamp shoe holds flat and rounded shapes, as well as 90°.



Makes a perfect companion to the Kreg Mobile Project Center.



Works on any bench with 3/4" bench dog holes—or drill your own.



ITEM# KBCIC

CLASSIC FACE CLAMPS

Classic Face Clamps are designed for creating perfectly flush Kreg Joints.™ They also work great for lots of other shop and project tasks that require solid clamping without marring. These clamps feature large clamp pads that distribute clamping force evenly, and hold pieces flush during assembly. When used in Kreg Joinery,™ the extra-large clamp face gets positioned on the “show” side of the joint.

Classic Face Clamps are available in two sizes: 2" (51mm) reach and 3" (76mm) reach. Both have a simple screw that adjusts the clamp to match material thickness, plus comfortable padded handles. Both are compatible with Clamp Adapter on 300-Series Pocket-Hole Jigs.



ITEM# KHC-MICRO

CLASSIC 2" FACE CLAMP

2" (51mm) reach; clamps materials up to 2 1/4" (57mm) thick. This easy-to-use, compact clamp fits easily into tight spaces.



ITEM# KHC-PREMIUM

CLASSIC 3" FACE CLAMP

3" (76mm) reach; clamps materials up to 2 3/4" (70mm) thick. Offers increased reach and clamping capacity.



STURDY

Classic Face Clamps are designed for creating perfectly flush Kreg Joints.™ They also work great for lots of other shop and project tasks that require solid clamping without marring.

VERSATILE

Classic Face Clamps make it easier to build using Kreg® 300-Series Pocket-Hole Jigs by locking securely onto the Clamp Adapter.



CLAMP TABLE AND STEEL STAND COMBO

The Clamp Table is the ultimate clamping solution for Kreg Joinery™ and works with the entire family of Kreg® Bench Clamp products. Now this versatile table is even better with the addition of Automaxx® Clamping.

If you've ever struggled to get perfectly flush Kreg Joints,™ failed to get your clamps positioned exactly where you need them, or needed an extra set of hands around the workshop, the Clamp Table is the perfect solution.

Made from glue-resistant melamine, this large 21 ¾" (552mm) x 33 ¾" (857mm) work surface is perfect for sanding, sawing, drilling, routing, joining, and almost any other woodworking task.

Available two ways: As a complete system with a heavy-duty stand, or with everything except the stand.



ITEM# KCT-COMBO

AUTOMAXX®

CLAMP TABLE WITH AUTOMAXX®

- Large 21 ¾" (552mm) x 33 ¾" (857mm) clamping surface
- Glue-resistant melamine surface
- Clamp Trak™ on two sides of the table provides endless flexibility
- Clamp Blocks™ allow for fast, accurate, and consistent registration of work pieces
- Can be used for a variety of woodworking functions, including sanding, routing, and layout

MULTI-PURPOSE SHOP STAND

- Heavy-duty 12- & 16-gauge steel
- Adjustable: 31" (787mm) to 39" (990mm)
- Four stable leveling feet
- Highly durable powder coated steel
- Fast and easy assembly

MAKE IT MOBILE



ITEM# PRS3090

Heavy-Duty Casters

Add mobility to your Multi-Purpose Shop Stand. Includes four heavy-duty casters. Dual-locking mechanism protects against caster roll and pivot. Weight capacity is 150 lbs. each. Includes all necessary hardware.



The Clamp Table holds workpieces securely and provides solid support for Kreg Joinery,™ drilling, sawing, sanding, routing, and more!

UNIVERSAL CLAMP TRAK™ KITS

Create your own clamping system that securely holds workpieces in place on your bench as you work. The Universal Clamp Trak™ Kit accepts Kreg® Bench Clamps (sold separately) that you can use to lock workpieces down while creating Kreg Joints™, sanding, routing, drilling, and much more. The long Traks™ allow you to position one, two, or more Bench Clamps exactly where you need them.

FEATURES

- Heavy-duty anodized aluminum construction
- 0.695" (17mm) thickness allows Trak™ to sit just below a ¾" (19mm)-thick surface
- Works with Kreg® Bench Clamps™
- Works with Clamp Blocks™



UNIVERSAL CLAMP TRAK™

KIT 27" x 45" (686mm x 1143mm)

Fits workbenches 30" x 48" (762mm x 1219mm) and larger

Note: Kit is compatible with Kreg Universal Bench (page 75)—20" x 44" (508mm x 1117mm) or 28" x 44" (711mm x 1117mm)



ITEM# KKS2745

INCLUDES

- | | |
|------------------------|--|
| (1) 27" (686mm) Trak™ | (1) Mounting Hardware and Instructions |
| (1) 45" (1143mm) Trak™ | |

UNIVERSAL CLAMP TRAK™

KIT 27" x 69" (686mm x 1752mm)

Fits workbenches 30" x 72" (762mm x 1829mm) and larger

Note: Kit is compatible with Kreg Universal Bench (page 75)—20" x 64" (508mm x 1625mm) or 28" x 64" (711mm x 1625mm)



ITEM# KKS2769

INCLUDES

- | | |
|------------------------|--|
| (1) 27" (686mm) Trak™ | (1) Mounting Hardware and Instructions |
| (1) 69" (1752mm) Trak™ | |

TWO EASY WAYS TO MOUNT YOUR TRACK

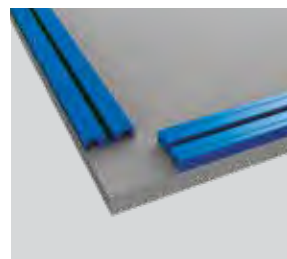

Surface Mount

Simply mount Traks™ to a 1" (19mm)-thick or thicker surface.

- Creates raised edges that can be used as workpiece stops and squaring aids
- Adds capacity to Bench Clamps™
- Works with any surface—single or multiple layer

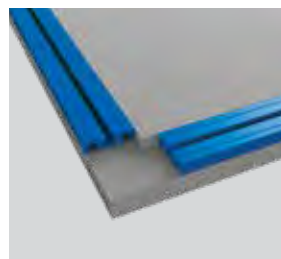

Flush Mount

Mount Traks™ to a ¾" (19mm)-thick or thicker surface, then add a ¾" (19mm)-thick layer to create a flush surface. Or, rabbet edges of bench top, and then mount Traks™

- Allows unobstructed bench top surface
- Retains standard Bench Clamp™ Capacity
- Allows use of Kreg Clamp Blocks™

CLAMP SYSTEM COMPONENTS

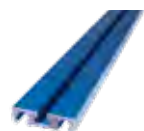

CLAMP TRAK™

Turn your workbench into a clamping station. Includes one 33 ¾" (857mm) aluminum extrusion. Compatible with Kreg® Bench Clamps™

ITEM# KKS1020

*hardware not included



CLAMP BLOCK SET

Register your workpieces for quick and easy squaring. Especially useful to make face frames. Durable impact-resistant plastic. Includes 5 plastic blocks and hardware.

ITEM# KKS1030



BENCH DOGS

These four ¾" Bench Dogs are great clamping aids. Made from ultra-durable, glass reinforced nylon. Included sticky rubber bench brakes keep workpieces from slipping.

ITEM# KKS1070

ROUTING

ROUTING SYSTEMS	50-53
ROUTING SYSTEM ACCESSORIES	54-57

FULL LINE OF PRODUCTS FOR TRUE PRECISION ROUTING

Kreg Routing Solutions offer the capability, versatility, and durability you need for true precision routing. We offer everything you need, whether you want a complete router table system for your shop, a portable model for use on the go, or you'd like to select your own components and accessories, and then build a router table yourself.



PRECISION ROUTER TABLE SYSTEM

The Kreg® Precision Router Table System combines unmatched versatility with incredible adjustability and ease of setup to take your woodworking projects to the next level. This powerful system offers a one-of-a-kind T-square style fence, a large, durable table top, and a sturdy steel stand that work together to create a router table that meets all of your precision routing needs.

Our exclusive Easy-Slide™ surface, Precision Insert Plate with Level-Loc Reducing Rings and uniquely designed accessories ensure that you get the best possible routing experience on each and every pass.



ITEM# PRS1045

SYSTEM INCLUDES

- Multipurpose, Self-Squaring Router Table Fence System
- High-Performance Table Top with Precision Insert Plate System Heavy-Duty, Adjustable Steel Stand Fence Micro-Adjuster

MAKE IT MOBILE



ITEM# PRS3090

Heavy-Duty Casters

Add mobility to your Multi-Purpose Shop Stand. Includes four heavy-duty casters. Dual-locking mechanism protects against caster roll and pivot. Weight capacity is 150 lbs. each. Includes all necessary hardware.

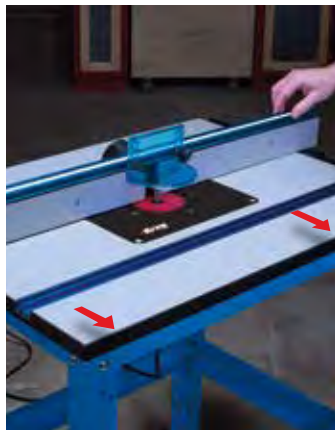

TABLE SAW FUNDAMENTALS

Table saw-style T-square adjustment system ensures the fence will always stay parallel to the miter-gauge slot. The fence adjusts easily and locks firmly in place with dual locks.



UNPARALLELED PRECISION

Magnified measuring system with an adjustable scale allows accurate setup with any bit. Included Micro-Adjuster allows you to dial in precision measurements exactly.



BUILT-IN JOINTING FEATURE

Fully-independent fence faces and depth-setting rods quickly turn your portable router table into a vertical jointer. Depth rods are stored on the fence and can be positioned behind the faces, allowing for jointing depth adjustments of 1/16" (1.6mm) and 1/32" (0.80mm).

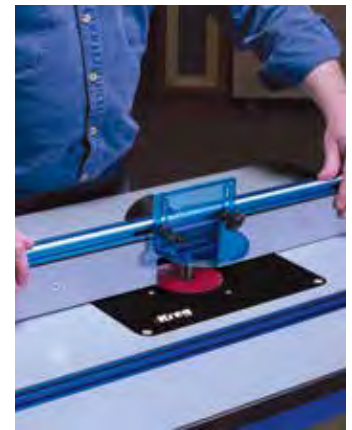

INDEPENDENT ADJUSTABLE FACES

Sliding fence faces can be positioned exactly where needed to provide workpiece support close to the bit, and to maximize chip collection into the fence's built-in dust port.

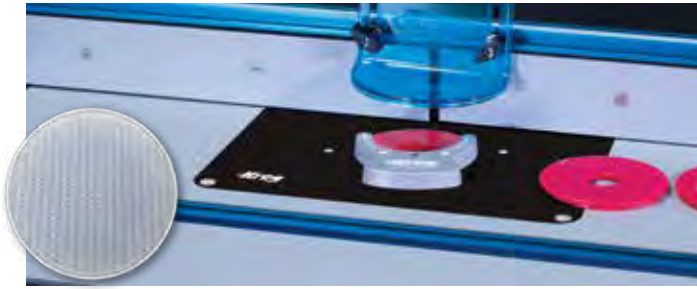

LOW-FRICTION EASY-SLIDE™ SURFACE

Durable, high-pressure laminate surface offers a low-friction Easy-Slide™ surface. Thick edgebanding protects the top against bumps and abrasions. Top has predrilled holes for mounting Precision Insert Plate Levelers.

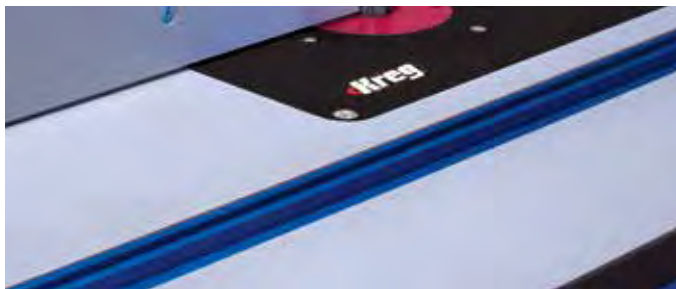

VERSATILE COMBINATION TRAK

The anodized-aluminum Combination Trak works with standard 3/8" x 3/4" (9.5mm x 19mm) miter gauge guide bars, and it accepts featherboards and other accessories. The T-track offers another way to mount jigs and fixtures for custom routing setups.

SPECS

PLATE OPENING DIMENSIONS	TABLE SURFACE	FENCE LENGTH	FENCE MATERIAL	OVERALL DIMENSION	WEIGHT	MULTI-PURPOSE SHOP STAND
3/8" x 9 1/4" x 11 3/4" (9.5mm x 235mm x 298mm)	24" x 32" (609mm x 813mm) with a 1"-thick (25mm) core	36" (914mm)	Heavy-duty anodized aluminum	36 1/2"H x 37 1/2"W x 25 1/2"D (927mm)H x (952mm)W x (648mm)D	94 lbs. (39kg)	<ul style="list-style-type: none"> • Heavy 12- & 16-gauge steel construction • Adjustable height: 31" (78.7cm) to 39" (99cm) • 4 stable leveling feet • Durable powder-coated finish • Fast and easy assembly

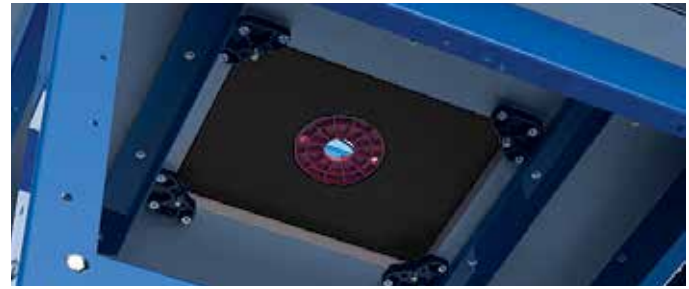

PRECISION COMBINED WITH DURABILITY

Four Precision Insert Plate Levelers allow you to set the plate flush for smooth, accurate routing. Steel reinforcing struts keep the 1" (25mm)-thick MDF table flat, even under the weight of heavy routers and lifts.

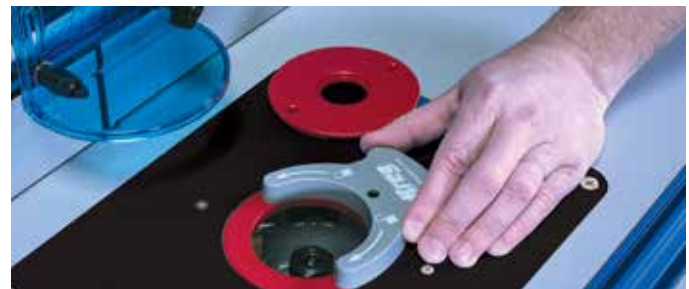

FEATURE-PACKED INSERT PLATE

The heavy-duty 3/8" (9.5mm) x 9 1/4" (235mm) x 11 3/4" (298mm) compression-molded insert plate handles large routers with ease. Level-Loc Reducing Rings lock in level and flush with the plate surface using the included ring wrench. A starter pin ensures controlled bit contact during freehand routing.

BUYING OPTIONS



ITEM# PRS1045

PRECISION ROUTER TABLE SYSTEM

This powerful system offers a large, durable table top, a one-of-a-kind T-square style fence, and a durable steel stand that work together to create a router table that meets all of your precision-routing needs. Includes Item #s PRS1025, PRS1015, and KRS1035.



ITEM# PRS1025

PRECISION ROUTER TABLE TOP

This 24" x 32" table top has a 1"-thick MDF core that absorbs vibration and offers mass to help create a stable router table. A tough Easy-Slide™ surface helps workpieces glide easily. Steel-reinforcing struts ensure that the table will stay flat.



ITEM# KRS1035

MULTI-PURPOSE SHOP STAND

This stand makes the perfect foundation for the Clamp Table™ and the Precision Router Table Top, and is great to create a custom shop stand. Includes four (4) leveling feet and assembly hardware. 20" (508mm) x 28" (711mm) footprint, 31" (787mm) to 39" (990mm) adjustable height.



ITEM# PRS1015

PRECISION ROUTER TABLE FENCE

This anodized-aluminum fence features a T-Square adjustment system that ensures the fence stays parallel to the miter-gauge slot. The fence adjusts easily and locks firmly in place with dual locks: a large paddle lock on the infeed end, and a quarter-turn lock on the outfeed end that prevents fence deflection.

PRECISION BENCHTOP ROUTER TABLE

The Precision Benchtop Router Table offers features that give it the capability of a full-size, industrial router table in a portable package.

The top is made from an edgebanded, vibration- and noise-resistant MDF, and features an Easy-Slide™ surface. The skin is constructed from a custom-textured laminate, which allows you to easily slide workpieces across the table.

The Precision Router Table Insert Plate measures 3/8" x 9 1/4" x 11 3/4" to support even the biggest routers, and it features Level-Loc Reducing Rings. These rings twist into place and lock in flush with the plate surface every time.

The heavy-duty aluminum fence features quarter-turn locking levers. They allow quick fence adjustment and confident locking, plus they are sized so they're easy to use but stay out of the way behind the fence. The fence also has independent sliding faces that provide increased workpiece support around the bit, and allow the table to be used as a vertical jointer.



ITEM# PRS2100



Lightweight yet durable, compact yet feature-packed, this router table is perfect for anyone who needs a router table on the jobsite or for anyone who wants all the features of a full-sized router table in a portable package.

SPECS

INSERT PLATE DIMENSIONS	TABLE SURFACE	FENCE LENGTH	FENCE MATERIAL	OVERALL DIMENSION	WEIGHT
3/8" x 9 1/4" x 11 3/4" (9.5mm x 235mm x 298mm)	24" x 32" (609mm x 813mm) with a 1"-thick (25mm) core	36" (914mm)	Heavy-duty anodized aluminum	36 1/2"H x 37 1/2"W x 25 1/2"D (927mm)H x (952mm)W x (648mm)D	94 lbs. (39kg)



EASY-SLIDE™ ROUTER TABLE TOP

This router's tabletop features the same Easy-Slide™ skin, made from the same impact-resistant, high-pressure laminate that is used on our full-size router table. This skin allows workpieces to glide across the table's surface easily.



BUILT-IN JOINTER

Fully-independent fence faces and depth-setting rods quickly turn your portable router table into a vertical jointer. Depth rods are stored on the fence and can be positioned behind the faces, allowing for jointing depth adjustments of 1/16" (1.6mm) and 1/32" (0.80mm).



FULL-SIZE LEVEL-LOC INSERT PLATE & LEVELERS

This full-size insert plate is the same compression-molded plate used in the large Kreg® router table,

which means you never have to compromise on functions or features. The plate is equipped with Level-Loc Reducing Rings that simply twist into place and lock in level and flush with the plate surface every time. Three rings are included: 1" (25mm), 1 3/16" (30mm) (for use with universal-style guide bushings), and 2 5/8" (67mm). The plate is mounted using Kreg® Precision Insert Plate Levelers, making it easy to set the plate exactly flush with the table surface.

PRECISION ROUTER LIFT

The Precision Router Lift elevates your routing capabilities by providing precise control when making router setup changes or changing bits. The lift replaces the standard insert plate in a router table (the $\frac{3}{8}$ " x $9\frac{1}{4}$ " x $11\frac{3}{4}$ " plate fits all Kreg® router tables plus many popular brands) and accepts any of 20+ popular router models—without the need for adapters or modifications—in a high-performance carriage that you raise and lower from above the table.

With the Precision Router Lift, there's no more reaching under the table to make adjustments or change bits, plus vastly improved control over all adjustments. Simply use the lift's included crank to adjust the height of your router bit easily and precisely from above the table. This makes adjustment fast, simple, and accurate so you can set up your router faster, and then dial in the exact bit height you require using the Precision Router Lift's built-in micro-adjustment scale. The lift also simplifies changing bits by allowing you to do that from above the table.

Precision is more than part of the name with this lift, too. The Precision Router Lift is designed so that every full revolution of the adjusting crank moves the carriage—and your bit—exactly $\frac{1}{16}$ ", though adjustments down to thousandths of an inch are possible. A built-in micro-adjust scale can be zeroed out at any point to establish your baseline bit setup, so you can make exact bit height changes, and readjust to the exact same setting confidently every time for repeatable cuts.

ELEVATE YOUR ROUTING CAPABILITIES



Take complete control of your table-mounted router to make accurate, repeatable, reliable adjustments plus above-table bit changes. The Precision Router Lift provides the high-quality results you need to shape raw wood into refined project parts.

FEATURES



OVERSIZE

Throat opening accepts Level-Loc reducing rings. (3 rings included).



PRECISE

Measurement dial for easy height change down to the thousandth of an inch.



SECURE

The router carriage can hold 20+ popular routers without the need for adapters.

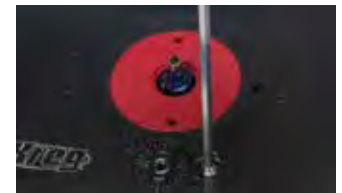

POSITIVE

Locking mechanism holds your bit setting exactly to ensure repeatable results.

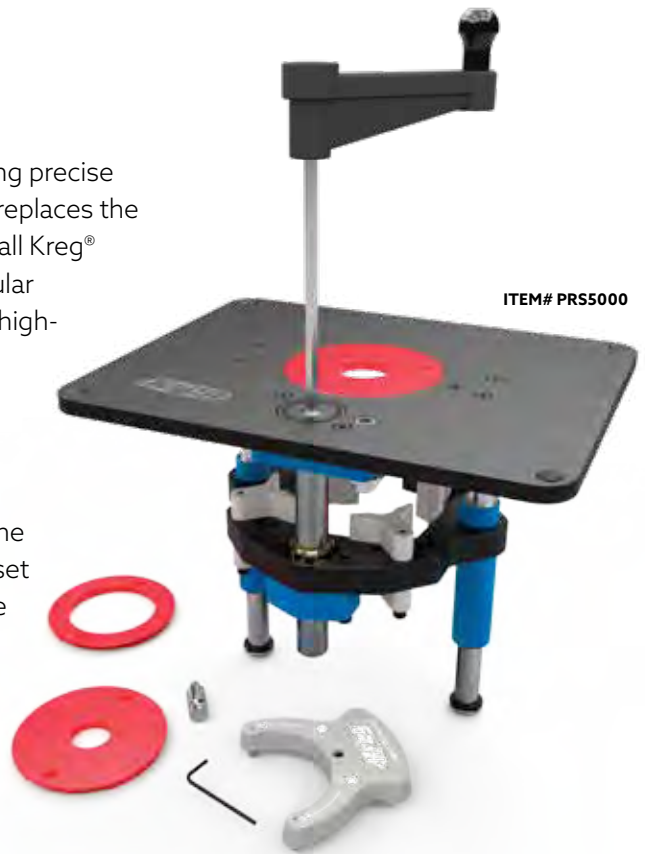

SPECS

- Bearing-guided carriage
- Hard-anodized aluminum plate
- Above-Table collet access
- Precision adjustment
- Accepts 20+ popular routers with out requiring adapters
- Fits all Kreg router tables, and many other brands

INCLUDES

- | | |
|------------------------------|----------------------------------|
| (1) Router Lift | (1) Ring Wrench |
| (1) Adjustment Crank | (1) Stainless Steel Starting Pin |
| (3) Level-Loc Reducing Rings | (1) Owner's Manual |

ROUTING ACCESSORIES

PRECISION ROUTER TABLE INSERT PLATE

Equip your router table with an insert plate that offers the features and durability you demand. The Precision Router Table Insert Plate is made from compression-molded phenolic, which is 30% stronger, and 20% more rigid than standard phenolic, meaning it starts out flat and stays flat, even when used with a large, heavy router.

The plate is equipped with Level-Loc Reducing Rings that simply twist into place using an included ring wrench to lock in level and flush to easily change the size of the opening around the router bit. Three Level-Loc Rings: 1" (25mm), 1³/₁₆" (30mm) for use with universal-style guide bushings, and 2 ⁵/₈" (67mm) rings are included.



LEVEL-LOC REDUCING RINGS

Change the size of the opening around your bit easily using these rings that simply twist into place and lock-in level and flush with the plate surface every time. Includes three rings: 1" (25mm), 1³/₁₆" (30mm) (for use with universal-style guide bushings), and 2 ⁵/₈" (67mm).

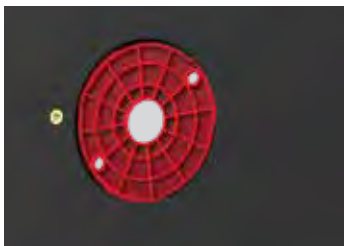

MOLDED-IN ALIGNMENT MARKS

The undrilled Insert Plate comes without pre-drilled holes, unlike so-called "universal" plates. Instead, it has molded alignment marks on the underside that make it extremely easy to center and mount your router.

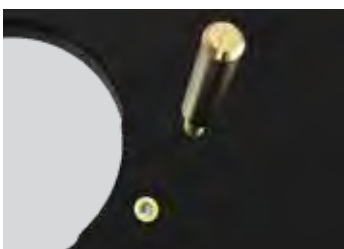

REMOVABLE STARTING PIN

This removable starting pin gives you the safety and control you need while routing freehand—without a fence to guide the workpiece past the bit—by providing a surface to rest your workpiece against before you pivot the workpiece against the bit.



WORKS WITH MOST ROUTERS

This 3/8" x 9 1/4" x 11 3/4" (9.5mm x 235mm x 298mm) plate is designed to easily accept most routers, and is built tough to resist sagging with even the largest, heaviest routers.

THE PRECISION ROUTER TABLE INSERT PLATE IS AVAILABLE IN THREE STYLES:

ITEM# PRS4034

Insert Plate predrilled to match the hole pattern of the Triton MOF001 and TRA001. (Also fits the Porter-Cable 7500 series by enlarging the mounting holes.)

Includes: Precision Router Table Insert Plate, three Level-Loc Reducing Rings, ring wrench, starting pin, and router mounting screws.

ITEM# PRS4036

Insert Plate predrilled to match the Porter-Cable 690 and 890, as well as the Bosch 1617.

Includes: Precision Router Table Insert Plate, three Level-Loc Reducing Rings, ring wrench, starting pin, and router mounting screws.

ITEM# PRS4038

Insert Plate without predrilled holes. Has shallow "starter holes" molded into the underside for popular router patterns, as well as a molded centering pattern.

Includes: Precision Router Table Insert Plate, three Level-Loc Reducing Rings, ring wrench, starting pin, and router mounting screws.

PRECISION ROUTER TABLE STOP

Bring greater accuracy and repeatability to your Precision Router Table with this uniquely designed stop. Features a low-profile, aluminum design, made to flip out of the way when not in use. The included Precision Lens Cursor gives you a clear and accurate view of the fence's tape.



ITEM# PRS7850

Compatible with Kreg® Precision Router Table and Precision Benchtop Router Table.



Design allows the stop to flip out of the way when not in use.



Get extra precision and unmatched repeatability for stopped dados & tenons.

MULTI-PURPOSE ROUTER TABLE SWITCH

Add safety and convenience to your Precision Router Table with this incredibly handy power switch. This unique switch features a two-plug design to control two independent devices at once, Key-Lok™ to eliminate accidental power-on, and an 8-foot long (2.4m), heavy-duty, 14-gauge power cord. This switch makes a perfect companion to our Precision Router Table and Precision Benchtop Router Table.



ITEM# PRS3100



Key-Lok™ eliminates unintentional power-on.



Dual-plug design controls two independent devices at once.

LEVEL-LOC REDUCING RINGS 5-PIECE SET



ITEM# PRS3050

This five-piece set of Level-Loc Reducing Rings fits the Precision Router Table Insert Plate (see page 54), allowing you to customize the size of the opening around the bit.



Includes rings with 3/4", 1 3/8", 1 5/8", and 2 1/8" openings, plus one "blank" ring.



Works with the Kreg® Precision Router Table Insert Plate

PRECISION ROUTER TABLE SETUP BARS



ITEM# PRS3400

These innovative setup bars feature three unique ways to ensure your projects get the precision they truly deserve. This set includes seven setup bars stored in a portable protective case. Sizes: 1/8" (3.2mm), 3/16" (4.8mm), 1/4" (6.4mm), 5/16" (7.9mm), 3/8" (9.5mm), 7/16" (11.1mm), 1/2" (12.7mm).



Concave step on the bottom of each setup bar straddles router bit or saw blade for precise height adjustment.



Step on the end of each setup bar precisely sets fence offset distances on the router table or table saw.

TRUE-FLEX™ FEATHERBOARD

The True-FLEX™ Featherboard gets its name from the careful engineering that went into its design. Many featherboards on the market today apply too much pressure or not enough pressure to the workpiece, which results in imperfect cuts and less-than-safe operation.

The True-FLEX™ Featherboard provides a consistent and optimum pressure, and will stand up to years of heavy use in your woodshop. The Featherboard is made from an extremely durable plastic composite body and includes a Wedge-Lock™ System that allows the Featherboard to be secured to a variety of shop tools without the need for additional hardware.

Whether you're using a miter slot or a T-slot, working on a table saw or a router table, the Wedge-Lock™ System adjusts accordingly and lets you work with confidence. Designed for use in standard $\frac{3}{8}$ " x $\frac{5}{8}$ " (9.5mm x 19mm) miter slot.



ITEM# PRS3010

TRUE-FLEX™ FEATHERBOARD

Single Featherboard. Comes with Wedge-Lock hardware that works in T-slots or miter slots on table saws, router tables, and band saws.



ITEM# PRS3020

TRUE-FLEX™ FEATHERBOARD TWIN PACK

Comes with an extended version of the Wedge-Lock hardware, perfect for stacking. When used together, they provide additional support for tall workpieces, resulting in higher-quality cuts.



True-FLEX™ fingers apply optimum pressure to your workpiece. Unique wedge-lock hardware works in $\frac{3}{8}$ " x $\frac{3}{4}$ " miter slots on tablesaws, router tables, and band saws.



Wedge-lock hardware allows the featherboards to be separated and used in two ways: miter slot or T-slot.

PRECISION ROUTER TABLE INSERT PLATE LEVELERS

These levelers are the easiest way to add an insert plate to a shop-built router table. They eliminate the need for a supporting rabbet and feature a unique bottom-mount design that includes eight adjustable contact points, four-corner lock-downs for stability, and locating tabs for easy installation.



ITEM# PRS3040



Plate Levelers mount easily to the underside of the table. Eliminates the need for a rabbeted opening.



Two adjustable set screws on each Leveler make it easy to set the router plate flush with the table surface.

PRECISION BEADED FACE-FRAME SYSTEM

Beaded face frames are a great way to add detail, richness, and value to your cabinetry work. The Precision Beaded Face-Frame System works in conjunction with your full-size router table to serve as the fastest, easiest, and most affordable way to build beaded face-frames in a home shop.

Through a process of precise notching of the rails and stiles, the Precision Beaded Face-Frame System simplifies standard beaded face-frame construction by eliminating the need to make intricate cuts on a table saw, fit and refit miters, or spend thousands of dollars on a large specialized machine. The end result is higher-quality, more-consistent results in less time and with less effort than before.



ITEM# PRS1200

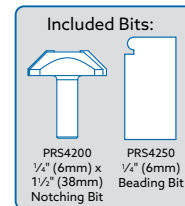

SkillBuilder™
DVD Included

INCLUDES

- (1) Kreg® 1/4" x 1 1/2" (6mm x 38mm) Notching Bit
- (1) Kreg® 1/4" Precision Setup Bar
- (1) Kreg® 1/4" Standard Beading Bit

HOW IT WORKS:



1) Use the control arm and smooth sliding base to plunge the stiles into the special notching bit.



2) Use the Precision Router Stop to ensure perfectly placed notches on the rails.



3) Switch to your standard routing fence and included beading bit to apply a decorative bead.



4) Use Kreg Joinery™ to secure the rails to the notched stiles. Glue is optional.



5) Done! Now it's time to sit back and enjoy the beauty that custom-made beaded face frames bring to your home.

FEATURES



SLIDING BASE

The sliding base of the Precision Beaded Face-Frame System features 20 internal stainless steel ball bearings that guarantee smooth operation over the long haul.



CONTROL ARM

The handle can be connected to the Precision Beaded Face-Frame System with or without the Control Arm. The arm provides improved control, smooth operation, and reduces the force necessary to plunge the workpiece into the bit.



INTEGRATED CLAMP

This heavy-duty clamp holds your workpieces firmly in place. Features a quick-release handle and adjustability for stock thickness.



ROUTER TABLE STOP

The included Precision Router Table Stop lets you repeat cuts at the exact same measurement again and again. It features a Precision Lens Cursor for magnified accuracy and can be conveniently flipped out of the way when not in use.

OPTIONAL PROFILES

Searching for a more unique look? We have all the profiles you need to get the job done right. These special bits are designed for use with the Precision Beaded Face-Frame System.

Each bit features a 1/2"-shank along with durable, high-grade carbide tips. At right are our three beading bits and four standard notching bits. Visit www.kregtool.com for more information.

Beading Bits



PRS4250 1/4" (6mm) Bit
PRS4255 3/8" (8mm) Bit
PRS4260 3/8" (10mm) Bit

Notching Bits

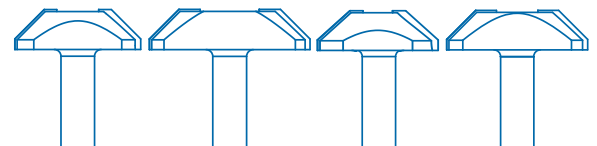

PRS4200 1/4" x 1 1/2" (6mm x 38mm)
PRS4205 1/4" x 2" Bit (6mm x 50mm)
PRS4210 3/8" x 1 1/2" (10mm x 38mm)
PRS4215 3/8" x 2" (10mm x 50mm)

HARDWARE INSTALLATION

DECK JIG	60
CABINET & SHELF JIG	61-64
MEASURING	65

ADD THE FINISHING TOUCH TO YOUR PROJECTS EASILY

Kreg Hardware Installation Solutions make it easy to add the perfect final touch to your projects by allowing you to confidently install knobs and pulls, concealed door hinges, drawer slides, and adjustable shelves with accurate, repeatable, professional-quality results every time.



Cabinet Hardware Jig

Concealed Hinge Jig

Shelf Pin Jig

Drawer Slide Jig

DECK JIG™

With the Kreg® Deck Jig™ and a few simple tools you already own, you can create a beautiful, functional deck surface that is completely free of exposed fasteners and painful splinters. Concealed-decking systems utilize awkward steel fasteners or thin plastic clips to hold your deck boards in place. The Deck Jig™ utilizes a more straightforward approach, creating an incredibly strong wood-to-wood bond through precisely-placed self-tapping screws.



INCLUDES

- (1) Deck Jig™
- (1) 6" (152mm) Deck Jig™ Drill Bit
- (1) 6" (152mm) KTX Square-Drive Bit
- (3) 1/4" (6mm) Deck Jig Spacer Rings
- (2) Stop Collars
- (1) Hex Wrench

SPECS

- Spacers set distance between deck boards for consistent spacing
- Standard deck screws work with 4/4 to 5/4 (3/4" to 1 1/8") stock
- 2 5/8" deck screws are required for use with 2x material, including 2x4s, 2x6s, 2x8s, etc.



FUNCTIONAL

An oversized, ergonomic, easy-grip handle gives you a secure hold and complete control over each and every hole you drill.



PRECISE

Three hardened-steel Kreg® drill guides keep the specialized stepped drill bit and driver bit at the precise, optimal angle.



ACCURATE

Three handy spacer rings – three 1/4" (6mm) – ensure accurate deck board spacing for proper drainage and a longer deck life.

ACCESSORIES



DECK JIG™ DRILL BIT / DRIVER BIT

The Deck Jig™ drill bit and driver bit both feature hardened-steel construction and Quick-Change compatible hex shanks. Both bits are designed to work exclusively with the Kreg Deck Jig™ and come complete with a stop collar and hex wrench to help control your plunge depth.

ITEM# KJD/DECKBIT and DECKDRIVER



DECK JIG™ SPACER RINGS

Ensure consistent spacing between deck boards as you drive the screws. Rings feature a large handle for quick, easy placement. Works with the Kreg Deck Jig™. Available in 1/4" (6mm). Set of 12.

ITEM# DECKSPACER-RED

CABINET HARDWARE JIG

Whether you're installing one new knob or dozens of drawer pulls, the Cabinet Hardware Jig takes the guesswork out of the process, ensuring accuracy and consistency every time. A movable edge guide and built-in measuring scales (with imperial and metric markings) make it easy to position knobs precisely.

Plus, the Cabinet Hardware Jig features movable, hardened-steel drill guides that lock in place to align with common hole-spacing measurements for cabinet knobs and pulls. The guides make it simple to drill straight, accurately positioned holes. The jig works with almost any style of knob or pull, too, making it exceptionally versatile.



ITEM# KHI-PULL

SPECS

- Drill guides: two movable $\frac{3}{16}$ " guides with locking nuts
- Hardened-Steel Drill Guides
- Drill guide spacing: Centered, 2 $\frac{1}{2}$ ", 3", 3 $\frac{1}{2}$ ", 4", 4 $\frac{1}{2}$ ", 5", 64mm, 96mm, 128mm
- 1" to 5" (25mm-127mm) edge guide to hole center spacing
- Imperial and metric measuring scales

INCLUDES

- (1) Jig Base
- (1) Edge Guide
- (2) Drill Guides with Knurled Nuts
- (2) Non-Slip Pads
- (2) T-knobs and Bolts
- (1) Owner's Manual

NOTE: $\frac{3}{16}$ " (4.5mm) drill bit required. Not Included.



EASY

Easily set the jig to locate knobs or pulls exactly where desired.



ACCURATE

Drill straight mounting holes accurately using built-in hardened-steel drill guides that keep the bit straight.



REPEATABLE

Confidently mount hardware after drilling the holes, knowing that it will fit correctly every single time.



CONCEALED HINGE JIG

The Concealed Hinge Jig takes the guesswork out of installing cabinet doors using concealed hinges. With this easy-to-use jig, you get drill-press accuracy using an ordinary hand drill. The jig ensures accurate hinge alignment for doors that fit perfect and work well. Plus, the Concealed Hinge Jig comes with a high-quality carbide-tipped bit with a built-in stop collar that ensures smooth, clean holes that are always drilled to the perfect depth.

The Concealed Hinge Jig consists of a glass-filled nylon base with a hole that receives a drill guide. Indexing cams ensure that the jig positions the bit to drill a hole at the required offset—which is dictated by each hinge—and an included stop collar ensures that the cup depth is correct every time. A pair of smaller holes also allow drilling perfectly-positioned holes for the hinge mounting screws, ensuring that the hinge will fit accurately every time.



ITEM# KHI-HINGE

INCLUDES

- (1) Jig Base with Index Cams
- (1) Drill Guide
- (1) 35mm Carbide-Tipped Drill Bit
- (1) Stop Collar with Hex Wrench
- (1) Owner's Manual

NOTE: 1/16" (1.5mm) drill bit required for hinge-mounting screws not included.

SPECS

- Compatible with 35mm cup-style concealed hinges
- Works with 3mm, 4mm, 5mm, 6mm hinge offsets
- Four-cutter, carbide-tipped drill bit with stop collar
- 2" (50mm) to unlimited hinge offset from door end



EASY

Use the cams and measuring scale to easily set the jig to position the hinge cup precisely, and then drill a hole precisely using any drill.



ACCURATE

Drill holes for the hinge mounting screws, as well, using guide holes in the jig to ensure accurate results.



REPEATABLE

Confidently install hinges that fit perfectly every single time for doors that fit right and look great.

ACCESSORIES

35MM CONCEALED HINGE BIT:

This high-quality carbide-tipped drill bit is the same one that comes with the Concealed Hinge Jig. It features four carbide cutters: Two large cutters that create a smooth, flat-bottomed hole, plus two spur cutters that shear the hole sides cleanly for a straight, smooth hinge cup. Stop collar not included.



ITEM# KHI-BIT



DRAWER SLIDE JIG

Whether you're updating cabinets or you're building a project from scratch, mounting drawers is always a challenge. The Drawer Slide Jig takes the guesswork out of installing drawer slides, ensuring drawers that fit perfectly and slide smoothly. The Drawer Slide Jig works with slides of all kinds—ball-bearing, epoxy-coated, and undermount—and can be used in face-frame and frameless cabinets.

This easy-to-use jig has two brackets that hold slides in position as you drill mounting holes in the cabinet. Built-in tabs make the brackets easy to align on cabinets with face frames, or with your designated marks on frameless cabinets. Of course, mounting slides inside the cabinet is only half the battle. That's why the Drawer Slide Jig brackets are reversible, as well, to support drawer boxes while mounting slides to the drawer.



ITEM# KHI-SLIDE

INCLUDES

- (2) Brackets with Adjustment Tabs
- (1) Owner's Manual

SPECS

- Dual-position Indexing Tabs
- Works with face-frame and frameless cabinets at least 14" deep
- Works with ball-bearing, epoxy-coated, and undermount slides



ACCURATE

Tabs register the jig to the cabinet side and frame for foolproof positioning.



ADAPTABLE

Works with face-frame cabinets, cabinets without frames, and on cases of other types, such as chests and dressers.



VERSATILE

Also supports the drawer box during installation to make the process easy.



SHELF PIN JIG

Whether you're adding shelf pin holes to an existing piece of furniture or you're building shelves from scratch, the Shelf Pin Jig is the perfect tool for the job. Unlike other shelf pin guides, the Shelf Pin Jig features hardened-steel drill guides that ensure precise and straight drilling, so you'll get level, wobble-free shelves.

The Shelf Pin Jig also includes a removable, dual-position fence that can be used to position holes either 1" or 2" (25mm or 50mm) from the edge, a locating pin that provides accurate spacing when you move the jig, and a jig extender that lets you connect multiple Shelf Pin Jigs together for high-speed production work. Available with either a 1/4" or a 5mm brad-point bit, and a depth collar that can be stored on the bottom side of the Shelf Pin Jig when not in use.



KMA3200
- Shelf Pin Jig with 1/4" Bit

KMA3220
- Shelf Pin Jig with 5 mm Bit

SPECS

- Dual-Position Fence, adjustable for 1" & 2" offset (25mm or 50mm)
- 32mm hole spacing

INCLUDES

- (1) Shelf Pin Jig
- (1) Locating Pin
- (1) Jig Extender
- (1) Drill Bit & Stop Collar
- (1) Hex Wrench
- (4) Sample Shelf Pins
- (1) Owner's Manual



DURABLE

Hardened-steel drill guides ensure precise drilling. Accepts our 1/4" and 5mm brad-point bits.



EASY

A built-in fence aligns with the edge of the workpiece to set the proper offset between the edge and the holes. The fence is removable for working inside a case.



REPEATABLE

A locating pin lets you confidently move the jig and reference last hole drilled.



EXPANDABLE

An included jig extender can be used to connect two or more jigs together.

ACCESSORIES

ADDITIONAL DRILL BITS:

Choose between 1/4" (6mm) and 5mm bits. 5mm bit features stepped design that allows it to fit precisely inside the Shelf Pin Jig's drill guides. Both bits include stop collar and hex wrench.



ITEM#
KMA3210

(1/4")



ITEM#
KMA3215

(5MM)

MULTI-MARK™

The Multi-Mark™ is an incredibly handy multipurpose marking and measuring tool, perfect for a wide variety of household and job-site applications. The Multi-Mark™ features three scale configurations, a built-in level, a 3/16" (5mm) reveal gauge, and much more. Whether you need to transfer a measurement, lay out mitered corners, or align and straighten picture frames, the Multi-Mark is the only tool you'll need to get the job done. Has imperial and metric markings.



Shown in 3 Configurations

ITEM# KMA2900

HUNDREDS OF USES

The Multi-Mark™ doesn't know the meaning of the term 'single-purpose.'



Lay Out Mitered Corners



Set 3/16" (5mm) Reveals



Transfer Measurements



Align / Square Your Projects



Set Bit / Blade Heights



Level Your Work

SPECS

- Three measuring scales
- Imperial and metric scale
- Built-in torpedo level
- 3/16" (5mm) reveal gauge
- Durable, compact design

MEASURING TAPES

IMPERIAL 12' SELF-ADHESIVE TAPE (3658MM)

This 1/2" (13mm) wide, self-adhesive measuring tape fits snugly into the recess on the top edge of our Top Trak and Heavy-Duty Trak. Metallic tape is highly scuff-resistant and can be trimmed to length with a scissors.

METRIC 3.5-METER SELF-ADHESIVE TAPE (3500MM)

Metric 3.5 meter (3500mm) tape is self-adhesive and fits snugly into the recess on the top edge of our Top Trak and Heavy-Duty Trak. Metallic tape is highly scuff-resistant and can be trimmed to length with a scissors.



- ITEM #KMS7723 Tape (12' R/L reading) (3658mm)
- ITEM #KMS7724 Tape (12' L/R reading) (3658mm)



- ITEM #KMS7728 Tape (3.5-meter R/L reading) (3500mm)
- ITEM #KMS7729 Tape (3.5-meter L/R reading) (3500mm)

WORKSPACE

BENCH SYSTEMS	68-69
MOBILE PROJECT CENTER	70-71
TRACK HORSE	72

VERSATILE, STURDY SOLUTIONS TO MAKE ANY PLACE YOUR WORKSPACE

Kreg Workspace Solutions allow you to make any place your workspace. Whether you work in a dedicated shop, in your garage, or on your driveway or patio, Kreg offers a solution that makes it easy to create a hardworking, sturdy workspace that suits your space, your tasks, and your needs.



Universal Bench

Mobile Project Center

Track Horse

UNIVERSAL BENCH

Get organized and create great work space with the Kreg® Universal Bench. You can easily create a workbench, assembly table, tool stand, or outfeed table in a custom size to fit your space, your projects, and your needs. Just choose your height, width, and depth to create a custom workbench in one of 15 sizes—from 14" (355mm) x 14" (355mm) up to 64" (1600mm) x 64" (1600mm)—and two adjustable heights. Bench legs come with a code to access free, downloadable under-bench storage plans.



*Image shown with optional Casters (available separately) and with custom user-built bench top and shelf

SPECS

LEGS

- Sold in sets of 4
- 12-gauge steel
- Adjustable height (17 ¼" to 23 ¼" or 31" to 39") (438mm to 584mm or 787mm to 990mm)
- Includes leveling feet and assembly hardware

RAILS

- Sold in sets of 4
- 16-gauge steel
- Five lengths:
 - 14" (355mm), 20" (508mm), 28" (711mm), 44" (1100mm), 64"(1600mm)

WEIGHT CAPACITY

- 600 lbs.

TOP/SHELF

- Supplied by user



HIGH-QUALITY HARDWARE

Zinc-coated carriage bolts lock into square holes for easy one-wrench assembly. They ensure that the bench remains rock-solid during use.

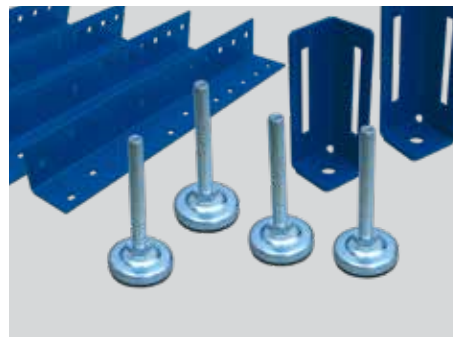

ADJUSTABLE LEG LEVELERS & FEET

Legs offer 8" (152mm) of unlimited height adjustment so you can match the height of your table saw or another bench. Leg levelers accommodate uneven floors.



PRE-DRILLED HOLES

Holes allow you to drop the upper rail down to add a storage shelf, drawers, create clearance for a vise, or add other custom touches to your bench.



STURDY LEGS

Legs are made from heavy 12-gauge steel and are available in two adjustable heights: 17 ¼" to 23 ¼" or 31" to 39" (438mm to 584mm or 787mm to 990mm).



5 DIFFERENT RAIL LENGTHS

Now you can create the professional-quality bench you've always wanted for your garage or workshop, and customize it to the tasks you choose.



CUSTOMIZE TO FIT YOUR NEEDS

Add a top, shelf, and other touches to complete your bench using your materials. A code to access downloadable storage plans comes with the legs.

CHOOSE THE LEG HEIGHT

Universal Bench legs are available in two heights. Both are adjustable.

- Standard-Height Legs are adjustable from 31" to 39"
- Low-Height Legs are adjustable from 17 1/4" to 23 1/4"

CHOOSE THE RAIL LENGTHS

Universal Bench Rails are available in five lengths (14", 20", 28", 44", 64").

Choose one set of rails (four included) to establish the bench width you want.

Choose another set to establish the bench depth.



BUYING OPTIONS

KBS500	(4) 17 1/4" to 23 1/4" (438mm to 584mm) Legs
KBS1000	(4) 31" to 39" (787mm to 990mm) Legs
KBS1005	(4) 14" / 355mm Rails
KBS1010	(4) 20" / 508mm Rails
KBS1015	(4) 28" / 711mm Rails
KBS1020	(4) 44" / 1100mm Rails
KBS1025	(4) 64" / 1600mm Rails

MAKE IT MOBILE



ITEM# PRS3090

Heavy-Duty Casters

Add mobility to your Multi-Purpose Shop Stand. Includes four heavy-duty casters. Dual-locking mechanism protects against caster roll and pivot. Weight capacity is 150 lbs. each. Includes all necessary hardware.

CHOOSE YOUR
HEIGHT

CHOOSE YOUR
WIDTH

CHOOSE YOUR
DEPTH

28" x 28"
71,12 cm x 71,12 cm

14" x 14"
35,56 cm x 35,56 cm

14" x 20"
35,56 cm x 50,80 cm

14" x 28"
35,56 cm x 71,12 cm

14" x 44"
35,56 cm x 111,76 cm

14" x 64"
35,56 cm x 162,56 cm

20" x 20"
50,80 cm x 50,80 cm

20" x 28"
50,80 cm x 71,12 cm

20" x 44"
50,80 cm x 111,76 cm

20" x 64"
50,80 cm x 162,56 cm

28" x 64"
71,12 cm x 162,56 cm

28" x 44"
71,12 cm x 111,76 cm

44" x 64"
111,76 cm x 162,56 cm

44" x 44"
111,76 cm x 111,76 cm

64" x 64"
162,56 cm x 162,56 cm

MOBILE PROJECT CENTER

The Mobile Project Center gives you the freedom to work on projects wherever, whenever, and however you want. The Mobile Project Center sets up in no time, and can be used in multiple ways—as a workbench, a sawhorse, an assembly table, and a clamping station. Plus, the Mobile Project Center is a perfect companion for Kreg Joinery.™ When not in use, the Mobile Project Center stows away quickly and stores flat.

Whether you work in the garage, out on the driveway or patio, or in a workshop, the Mobile Project Center is ready for whatever tasks you can throw at it. If you need more work space, you can pair up two Mobile Project Centers by attaching them together with connecting keys to create a larger table surface, use the included support brackets and 2x4s to create a cutting platform, or throw a sheet of plywood on those 2x4s to create an extra-large work table.



- ✓ **Workbench**
- ✓ **Assembly Table**
- ✓ **Sawhorse**
- ✓ **Clamping Station**

HEAVY-GAUGE STEEL LEGS	STURDY TABLE BRACES	LOAD CAPACITY 350 POUNDS	VERSATILE EXPANDABLE DESIGN
-----------------------------------	------------------------------------	---	--

FEATURES



Organized storage trays hold hardware and small parts.

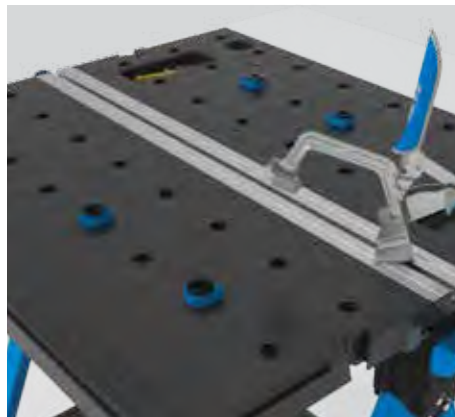

Hole pattern in top accepts included Bench Dogs and other accessories.



Included Trak™ bushings easily slide into the Trak to secure a 2x4 board and protect the Trak while cutting.



Clamp two ways: horizontally and vertically. Automaxx® technology adjusts clamp automatically so you can work faster.



Use the Bench Clamp like a vise to hold objects vertically as you work.

THE MOBILE PROJECT CENTER HELPS MAKE THE MOST OF THE TIME YOU HAVE

When you've carved out some time in your schedule to work on projects, you want to make the time as productive as possible. The last thing you want is to spend half your time setting up and tearing down. The Mobile Project Center sets up in no time by simply opening the legs and lifting the tables up, so you can get to the tasks at hand. Then it folds down for storage just as fast. That means you can quickly set up anywhere you need to, and get to work. Plus, the Mobile Project Center makes your time more productive by helping to support, hold, and organize your project and your tools while you work.

WORK MODES



WORKBENCH

Use 2x4s and plywood to create an extra-large bench surface. *Requires additional Mobile Project Center or Track Horse



SAWHORSE

Fold the tables down to create a sturdy sawhorse.



ASSEMBLY TABLE

Support projects on the large work tables during assembly.



CLAMPING STATION

Clamp workpieces in multiple, easy ways so you have both hands free.

WORK ON PROJECTS WHEREVER, WHENEVER, AND HOWEVER YOU NEED TO



Perfect for Every Project. Offers multiple work modes for amazing versatility



Increases Comfort While Working. Raises work to a convenient height and allows access from all sides



There When You Need It... Unfolds easily to get you set up and working in no time



Out of the Way When You Don't! Folds flat for easy carrying and compact storage

SPECS

- Large 27 3/4" x 31 1/2" (70cm x 80cm) work surface
- Durable polypropylene tables withstand rugged use
- Locking table supports with easy-release tabs
- 350 lb. (158kg) load capacity when used alone with tables raised
- 2,200 lb. (997kg) load when paired and used with tables lowered
- Comfortable 31 1/2" (80cm) table height
- 17 3/4" x 26" (45cm x 66cm) storage shelf
- Large, non-slip feet for stable footing
- Folds to just 6 1/2" (165mm) thick
- Weighs 40 lbs. (18kg)
- Expandable by pairing with a second Mobile Project Center or with a Kreg® Track Horse (page 72)

INCLUDES

- (1) Mobile Project Center
- (1) Bench Clamp with Automaxx® Technology

- (4) Kreg® Bench Dogs
- (2) Support Brackets
- (2) Trak Bushings
- (2) Connection Keys

INCLUDED ACCESSORIES



AUTOMAXX
AUTO-ADJUST TECHNOLOGY

KREG® BENCH CLAMP + 4 BENCH DOGS

TRACK HORSE

The Track Horse makes it easy to set up a sturdy work support anywhere to make any place your workspace. The Track Horse offers an array of features that give it capabilities beyond an ordinary sawhorse.

Steel and aluminum construction makes the Track Horse sturdy, and gives it a capacity of 2,200 lbs. (997 kg) per pair, so it can handle large, heavy projects and materials with ease. Dual-mode clamping (with an included Kreg Bench Clamp) makes it easy to secure those items on the Track Horse—by holding them down on the long track on top, or using keyhole brackets on the ends for vise-style clamping.

The track also accepts a sacrificial surface, which allows cutting without damaging the Track Horse or saw. When more cutting space is needed, just pair with another Track Horse or the Mobile Project Center to create a large cutting platform. Or set up an extra-large work table just as easily.

Adjustable legs feature six working heights to match any task. The legs also fold completely away, which allows the Track Horse to function as a ground-level work platform, and to store compactly away.

Track Horse can be adjusted to the following working heights: 6.63"/168mm (*ground-level with legs folded), 24.65"/626mm, 31.65"/804mm (matches height of Kreg Mobile Project Center), 32.65"/829mm, 33.65"/855mm, 34.65"/880mm, 35.65"/906mm.



SPECS

- Works alone, paired, or with the Mobile Project Center
- Made of heavy-gauge steel
- Adjustable legs offer six working heights
- Aluminum track accepts Kreg Bench Clamps (3" included)

INCLUDES

- (1) Track Horse
- (1) Kreg 3" Bench Clamp
- (2) Support Brackets
- (2) Track Bushings with screws
- (1) Owner's Manual



DUAL-MODE CLAMPING

The Kreg Track Horse utilizes hold-down clamping on the track, as well as vice style clamping at both ends using the included 3" Bench Clamp.

FEATURES



EXPANDABLE

Pair with another Track Horse or a Mobile Project Center to make a large work surface.



VERSATILE

Works as a sawhorse, a clamping station, and work support all in one.



STURDY

Made from heavy-duty steel and aluminum. Supports 2,200 lbs. as a pair.



ADJUSTABLE

Telescoping legs provide six working heights. Folds into a ground-level work platform.

APPAREL & ACCESSORIES



WOMEN'S JACKET

MED #GJACKETM-W
 LG #GJACKETL-W
 XL #GJACKETXL-W



WOMEN'S T-SHIRT - GRAY

MED #GSSM-W
 LG #GSSL-W
 XL #GSSXL-W



WOMEN'S POLO - BLUE

MED #BLPOLOM-W
 LG #BLPOLOL-W
 XL #BLPOLOXL-W



WOMEN'S POLO - GRAY

MED #GPOLOM-W
 LG #GPOLOL-W
 XL #GPOLOXL-W



MEN'S JACKET

MED #GJACKETM-M
 LG #GJACKETL-M
 XL #GJACKETXL-M
 XXL #GJACKETXXL-M



MEN'S T-SHIRT - GRAY

MED #GSSM-M
 LG #GSSL-M
 XL #GSSXL-M
 XXL #GSSXXL-M



MEN'S POLO - BLUE

MED #BLPOLOM-M
 LG #BLPOLOL-M
 XL #BLPOLOXL-M
 XXL #BLPOLOXXL-M



MEN'S POLO - GRAY

MED #GPOLOM-M
 LG #GPOLOL-M
 XL #GPOLOXL-M
 XXL #GPOLOXXL-M



KREG T-SHIRT - BLUE

SM #BSSS
 MED #BSSM
 LG #BSSL
 XL #BSSXL
 XXL #BSSXXL



KREG MUG

#MUG18



KREG HAT KHAKI

#HATKHAKI



KREG HAT BLACK

MED #GJACKETM-W
 LG #GJACKETL-W
 XL #GJACKETXL-W



YOUR PARTNER ➤ IN ◀ PROJECT BUILDING!

TOOLS

From setting up your shop to final project assembly, Kreg® tools provide solutions that are easy to use and built to last.

PLANS

Looking for project ideas? You'll find step-by-step project plans at Kregtool.com.

EDUCATION

Whether you need help with a product or another part of your project, Kreg is there to help with educational information.

HOW-TO

Learn techniques that will make your projects more successful at kregtool.com.

SUPPORT

Have a product or project question? Need more information? Experiencing an issue with a product? Our Customer Support Team is here to help by phone or online.

CONNECT WITH OTHER PROJECT BUILDERS

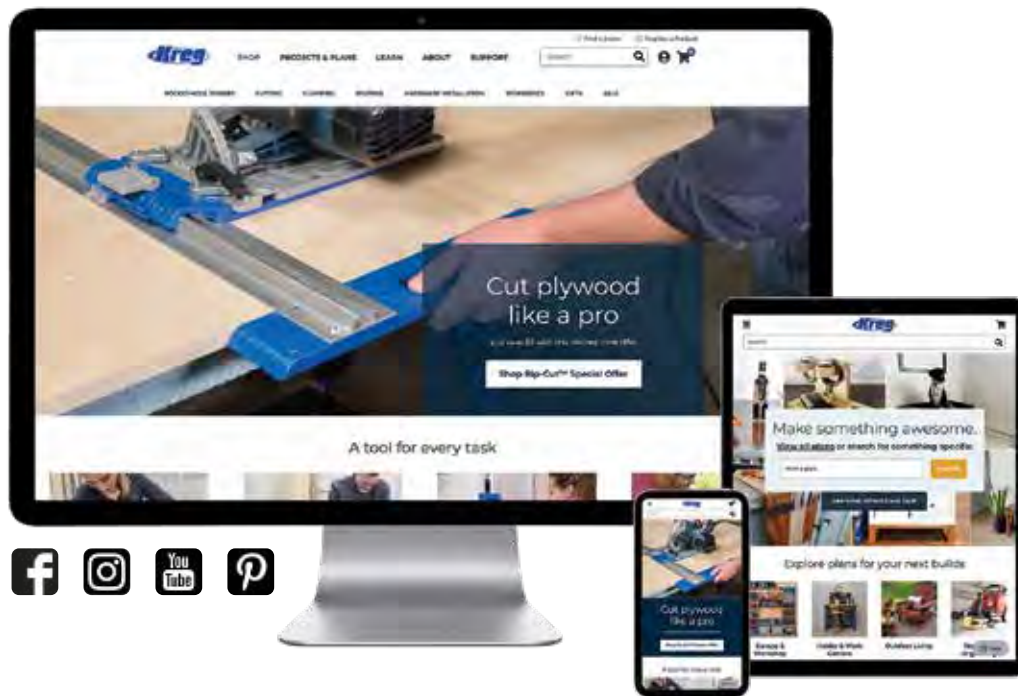

Kreg® makes it easy to connect with others who share your passion, and to get more information about building.

SOCIAL MEDIA

Connect with Kreg and other project builders on every major social media platform.

KREGTOOL.COM

Visit our website for product information, access to customer support, project inspiration, and much more.

NEWSLETTERS

Get tips, tricks, project ideas, and product information delivered right to your inbox. Sign up free at kregtool.com/newsletters.

Kreg Tool Company
201 Campus Drive
Huxley, IA 50124

PRSR STD
U.S. Postage
PAID
Des Moines, IA
Permit No. 589



ITEM# CATALOG-35

www.kregtool.com | 800-447-8638



Crosscut Station

Pg 28



Replaces all previous catalogs
Product offerings subject to change
without notice

Kreg Solutions Vol. 35 2021